



CONCERTA2™ LOUDSPEAKER SERIES

**CONCERTA**2™

 **REVEL**®  
The World's Finest Loudspeakers



## IN A CLASS BY ITSELF

The Revel® Concerta2 series of loudspeakers combines elegant design and superb finish quality with the best-in-class sound quality for which Revel is revered. Revel created the Concerta2 Series without sacrificing sound quality, beautiful design, or construction quality to meet lower price points. Instead, Revel engineers used the results of years of research to create superior waveguides, optimized transducers, new crossover topologies and novel port designs. These ingenious advances allowed Revel to create a series of loudspeakers that truly live up to the unmatched sound quality for which Revel is known.

REVEL

REVEL CONCERTA2 LOUDSPEAKER SERIES

---

## LOW-RESONANCE TWEETERS

Typical tweeter magnetic assemblies have a minute space behind the dome that causes a high fundamental mechanical resonance. In designing the Concerta2 series, this challenge was met head-on by Revel engineers. They created a tweeter with a mechanical resonance that is well below the operating band — which ensures linearity and consistency in the crossover region. To do so, a large cavity behind the magnetic assembly was designed, which is vented around the perimeter. This, along with a compliant diaphragm surround, sets the mechanical resonance frequency to a low 800Hz compared to a typical 1.5kHz found in similarly priced speakers. These advances allowed the tweeter/midrange crossover to be set an octave lower thereby improving the critical system directivity.

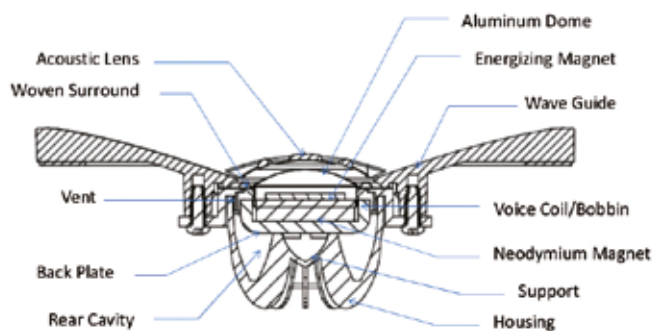



## TWEETER WAVEGUIDE AND ACOUSTIC LENS

Revel’s unparalleled research teams have discovered that far off-axis sound that is reflected from side walls is interpreted by our brains in combination with the direct sound from the loudspeaker to the listener—we do not differentiate between the two. This important advance in psychoacoustic knowledge means that the far off-axis response is just as important as the direct sound, and is therefore an important part of every Revel design. Our sophisticated high frequency “waveguides” match the off-axis response, or directivity of the tweeter and the midrange throughout the crossover region. Double-blind listening tests have revealed the importance of this refinement—making the difference between what is clearly a “mechanical reproduction” and the seamless sound of real music.

## WOOFER

Revel engineers utilize state-of-the-art computer modeling tools during transducer design to optimize everything that affects performance—from the cones to the voice coils, surrounds, the magnetic system and even the “spiders” — the brownish corrugated disc in the rendering to the right. Laser-based analysis of the resulting prototypes confirms ideal symmetry, which results in lowed distortion and cleaner sound quality. Micro-Ceramic Composite (MCC) cones insure ideal piston-like performance, eliminating resonances that would otherwise color the sound.

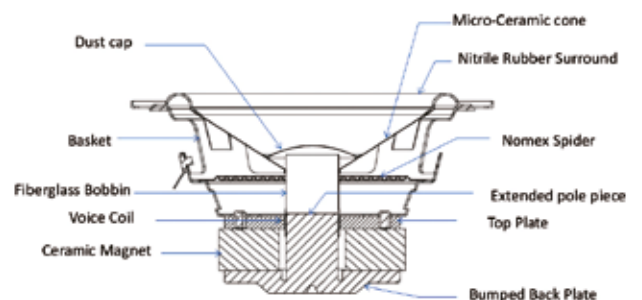

## BEAUTIFUL, HIGH-PERFORMANCE ENCLOSURES

A novel technique of cabinet construction was used to create Concerta2 enclosures that are not only beautiful, but also have rigid, curved side walls plus extensive bracing that results in a strong and inert enclosure. This ensures that the enclosures do not contribute coloration to the sound. The attractive designs are available in a luxurious high-gloss white or high-gloss black finish, have magnetically-attached grilles, and have no visible fasteners. These upscale features are typically seen only on far higher-cost loudspeakers.



## LATEST GENERATION PORT DESIGN

The Concerta2 series uses a patented Constant Pressure Gradient (CPG) technology in the port design. These new ports are designed such that the inner wall of the port is contoured, allowing the change in pressure along the axis of the port from inlet to outlet duct to be kept substantially constant. This design reduces the compression, or change in sound at different volumes that result from other port designs, and optimizes both the output capability and distortion.



## HIGH EFFICIENCY, HIGH OUTPUT TOWERS

Both the F36 and F35 floorstanding loudspeakers have a woofer-midrange that reproduces the full low frequency range in conjunction with two dedicated woofers. This architecture greatly increases the cone surface area, resulting in a remarkable system sensitivity of over 90dB. These towers are therefore an ideal match for a wide range of amplifiers, including very modestly-powered receivers.



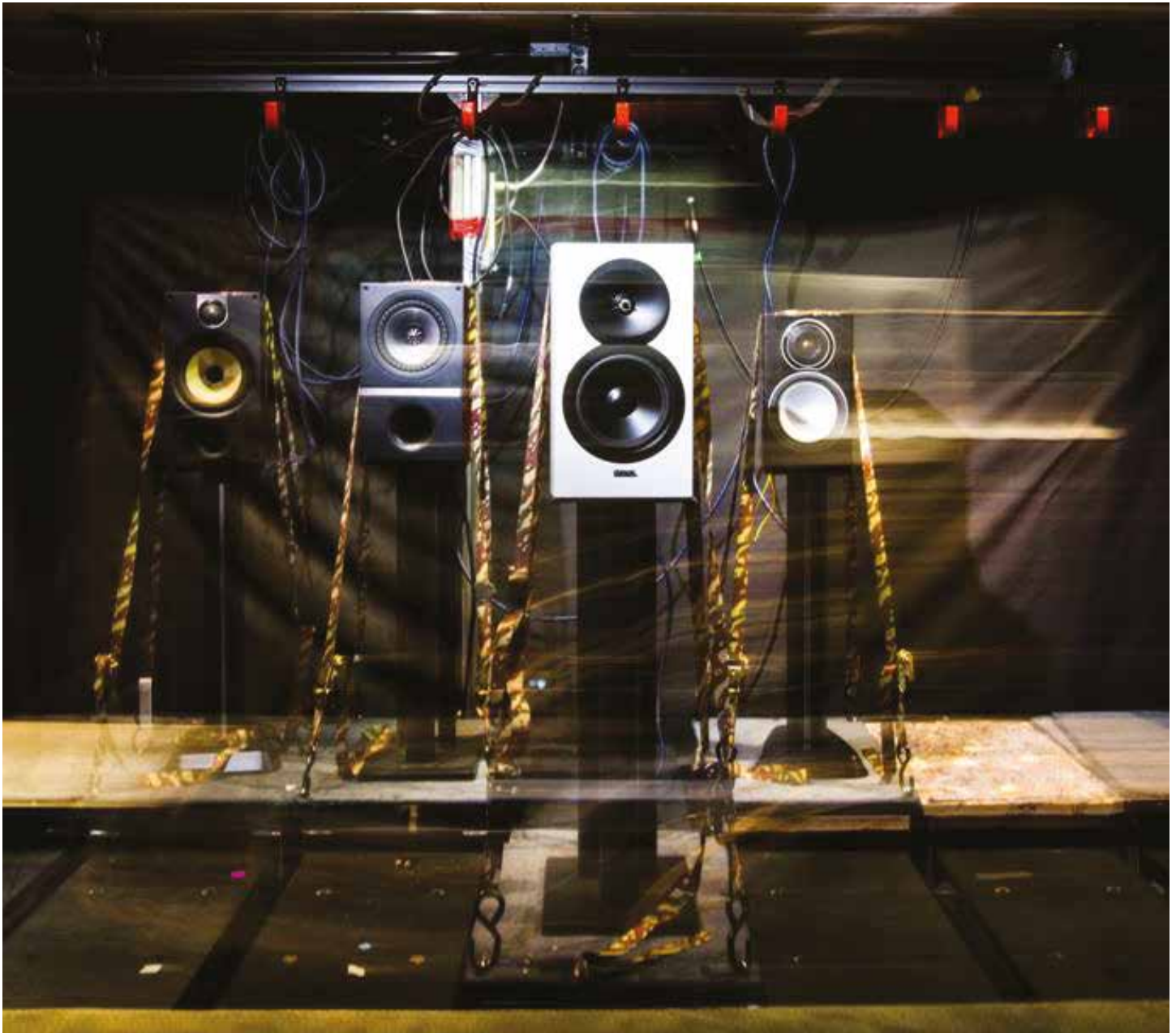







## POSITION-INDEPENDENT, DOUBLE-BLIND LISTENING TESTS

Every Revel loudspeaker is compared head-to-head with competitors' models in the world's only position-independent, double-blind listening facility. True research-quality processes assure the validity of the listening tests, which employ the latest psychoacoustic research. All Revel Concerta2 loudspeakers are proven to be superior to their market competitors before they go into production.

# REVEL® CONCERTA2™ LOUDSPEAKER SERIES | SPECIFICATIONS

MODEL	Description	Enclosure Type	HF Drive Component	LF/MF Drive Components	Crossover Frequency	Sensitivity (2.83V @ 1M)	Nominal Impedance	Recommended Amplifier Power	LF Extension (-3 dB -6 dB -10 dB)	Dimensions (H x W x D)	Weight
 <b>F36</b>	2-1/2-way Triple 6-1/2" Floorstanding Loudspeaker	Bass-Reflex via Rear-Firing Port	1" Aluminum Tweeter with Acoustic Lens and Waveguide	3 x 6-1/2" Aluminum Cone Woofers	600Hz, 1.8kHz	91dB	6 Ohms	30-200W	51Hz 45Hz 33Hz	44.25" x 9.65" x 12"	50 lbs
 <b>F35</b>	2-1/2-way Triple 5-1/4" Floorstanding Loudspeaker	Bass-Reflex via Rear-Firing Port	1" Aluminum Tweeter with Acoustic Lens and Waveguide	3 x 5-1/4" Aluminum Cone Woofers	575Hz, 1.8kHz	90dB	6 Ohms	30-180W	55Hz 46Hz 35Hz	40.25" x 8.42" x 12.2"	41 lbs
 <b>M16</b>	2-way 6-1/2" Bookshelf Loudspeaker	Bass-Reflex via Rear-Firing Port	1" Aluminum Tweeter with Acoustic Lens and Waveguide	6-1/2" Aluminum Cone Woofer	2.1kHz	86dB	6 Ohms	50-120W	55Hz 50Hz 45Hz	14.75" x 8.6" x 10.76"	16 lbs
 <b>C25</b>	2-way Dual 5-1/4" Center Channel Loudspeaker	Sealed	1" Aluminum Tweeter with Acoustic Lens and Waveguide	Dual 5-1/4" Aluminum Cone Woofers	2.1kHz	89dB	6 Ohms	40-120W	80Hz 68Hz 48Hz	7.25" x 19.45" x 10.1"	20 lbs
 <b>S16</b>	2-way 6-1/2" On-Wall Loudspeaker	Sealed	1" Aluminum Tweeter with Acoustic Lens and Waveguide	6-1/2" Aluminum Cone Woofer	1.8kHz	90dB	6 Ohms	30-120W	70Hz 58Hz 43Hz	14.75" x 13.3" x 5.5"	14 lbs
 <b>B10</b>	800 Watt 10" Powered Subwoofer	Bass-Reflex via Rear-Firing Port	n/a	10" Coated Fiber-Composite Cone, Cast-Frame Woofer	Variable 50 - 150Hz	n/a	n/a	800W Class D Amplifier	35Hz 32Hz 29Hz	16.45" x 14.85" x 15.45"	53 lbs

