

PURE

Evoke

C-D6 with Bluetooth



Evoke

C-D6 with Bluetooth

EN

DE

FR

IT

NL

DA/NO

Thank you for choosing Evoke C-D6 with Bluetooth. This manual will get you up and running in no time and explains how to make the most of Evoke's great features. If you need additional help with topics not covered in this manual, please visit the Pure support pages at support.pure.com.

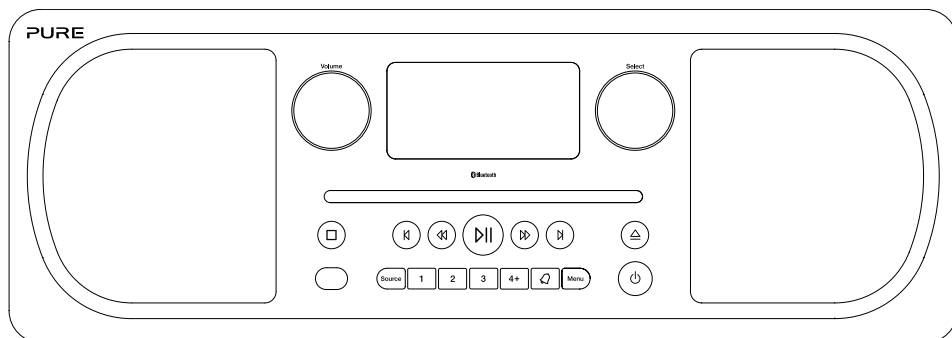

Safety information

1. Familiarise yourself with all of the safety information and instructions before using the radio. When passing this radio on to others, please include all documents.
2. The apparatus shall not be exposed to dripping or splashing and that no objects filled with liquids, such as vases, shall be placed on the apparatus.
If liquid or water is spilled on to the radio, switch it off at the mains immediately, disconnect the mains plug and contact your dealer.
Never touch the plug or the radio itself with wet hands. Never pull the power cable when disconnecting the power adaptor from the power supply.
3. The batteries (battery pack or batteries installed) shall not be exposed to excessive heat such as sunshine, fire or the like
4. Using the radio in rooms or climates with high humidity and temperatures may cause condensation to form inside the radio, which can damage the radio.
Use apparatus in moderate climates only.
5. Avoid extreme degrees of temperature, either hot or cold. Place the device well away from heat sources such as radiators or gas/electric fires. No naked flame sources, such as lighted candles, should be placed on the apparatus
6. The mains power adapter is used as the disconnect device, the disconnect device shall remain readily operable. Fit the mains adaptor to an easily accessible socket located near the radio and ONLY use the mains power adapter supplied.
7. Use only power supply listed in these user manual/user instructions (supplied by Pure with model number GPE036W-180200-Z) to power the equipment and do not use the power supply for any other purpose.
8. Ensure that the available supply voltage corresponds with the required operational voltage of the radio before use.
9. Disconnect your radio from the power supply if you will not use your radio for a long period of time (e.g. if you are going on holiday).
10. Always unplug your radio from the mains socket before cleaning. When cleaning the radio, do not use any type of abrasive pad or abrasive cleaning solutions as these may damage the radio's surface.
11. To reduce the risk of electric shock, do not remove any screws as there are no user-serviceable parts inside. Refer servicing to qualified personnel.

CAUTION

Danger of explosion if the battery in the remote control is incorrectly replaced. Replace only with the same or equivalent type.





WARNING

DO NOT INGEST THE BATTERY, CHEMICAL BURN HAZARD. The remote control supplied with this product contains a coin/button cell battery. If the coin/button cell battery is swallowed, it can cause severe internal burns in just 2 hours and can lead to death.

Keep new and used batteries away from children. If the battery compartment does not close securely, stop using the product and keep it away from children.

If you think batteries might have been swallowed or placed inside any part of the body, seek immediate medical attention.

Symbols on the product and in the user manual

Symbol	Description
	This WARNING symbol is used throughout this manual to indicate a potentially serious risk to your personal safety. Obey all safety notices that accompany this symbol to avoid possible injury or death.
	This symbol is used on the product to indicate a caution and that instructions should be read before use.
	This symbol indicates DC voltage.
	This symbol indicates where the product is switched on or put into standby.
	DC connector polarity, the centre of the connector terminal is positive.

4 Introduction

- 4 Front panel
- 5 Rear connectors
- 5 Remote control
- 6 Display
- 7 Changing the information shown on screen

8 Getting started

- 8 Quick start

9 Changing digital radio stations

9 Changing FM radio stations

10 Storing and selecting presets

- 10 To quick-store a station to a preset button (1-3)
- 10 To store a station to the preset list (4-10)
- 10 To recall a preset when listening to digital radio or FM radio

11 Playing a CD

- 11 Inserting a CD
- 11 Playing a track
- 11 Shuffling tracks
- 11 Repeating tracks
- 11 Ejecting a CD

12 Streaming using Bluetooth

13 Using the auxiliary input

14 Alarms and timers

- 14 Setting an alarm
- 14 Cancelling a sounding alarm
- 15 Snoozing a sounding alarm
- 15 Setting the sleep timer

16 Options and settings

- 16 Digital radio settings
- 17 FM radio settings
- 18 System settings

21 Technical specifications

Introduction

Front panel

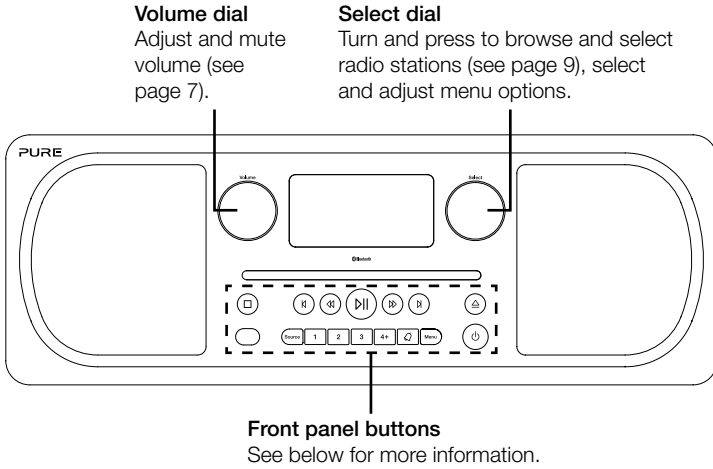

Front panel buttons

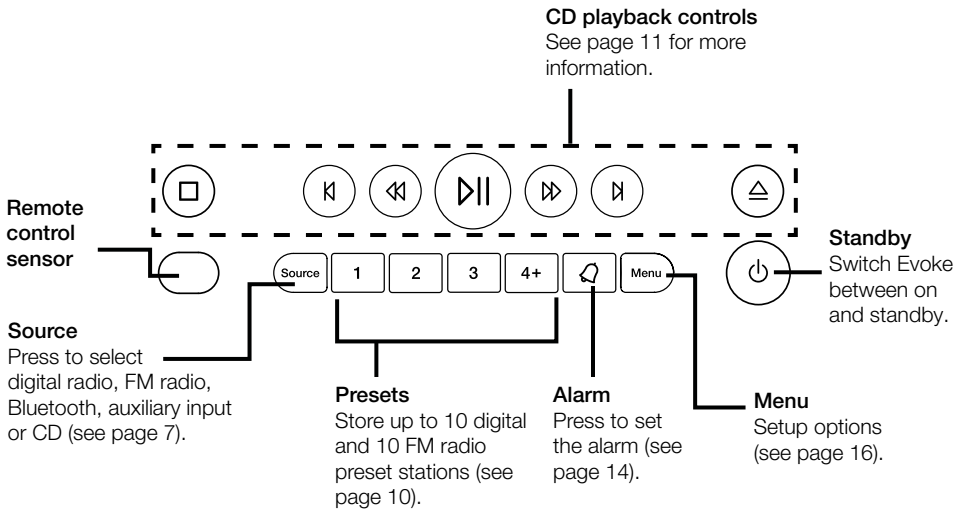

Rear connectors

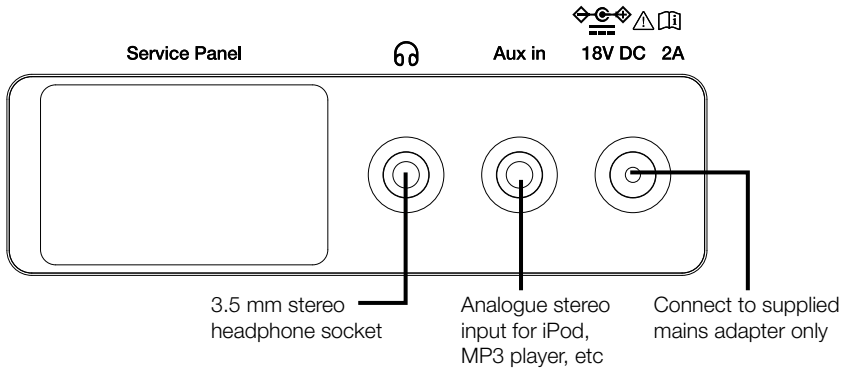

Remote control

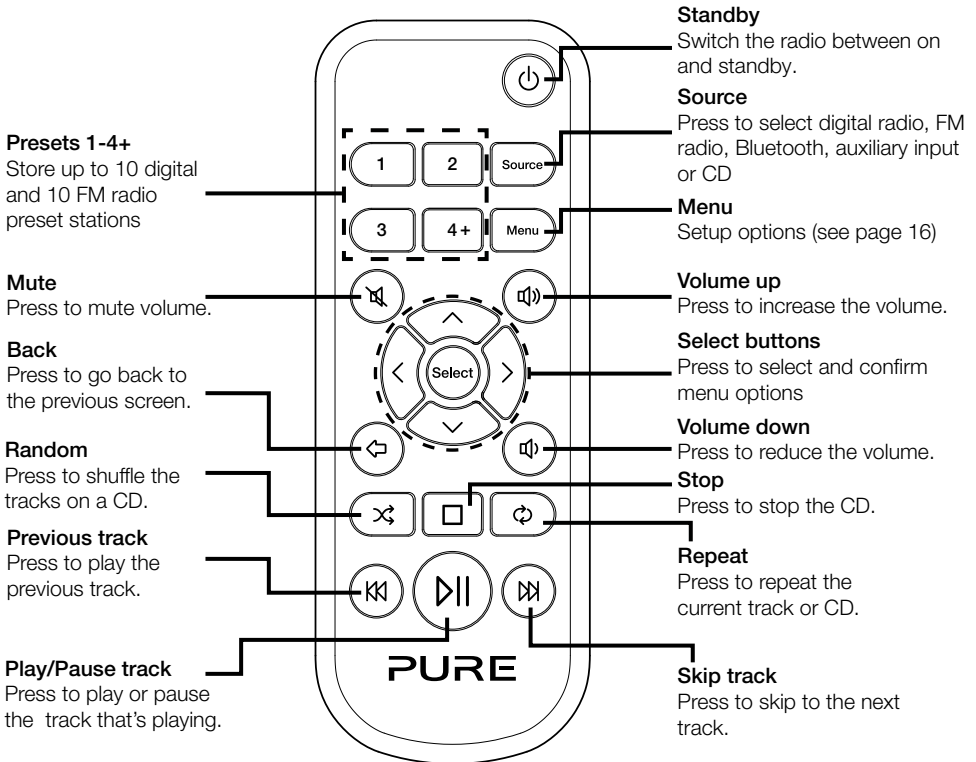

Display

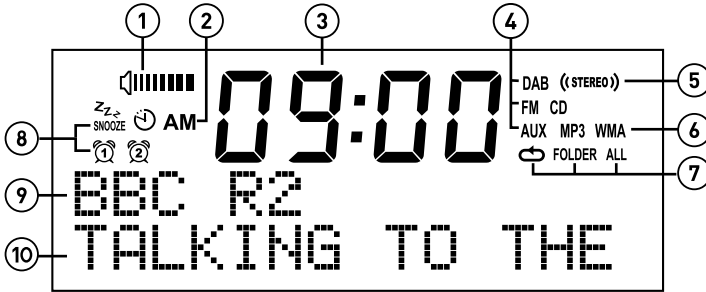

1. Volume indicator.
2. AM/PM indicator.
3. Displays current time.
4. Source indicator (DAB indicates digital radio, FM indicates FM radio, AUX indicates auxiliary input, CD).
5. Stereo indicator.
6. MP3 indicates that you've loaded a CD that contains MP3 files, WMA indicates that Windows Media Audio information is available for a CD that contains MP3 files.
7. CD repeat icons ( : Repeat the track that's currently playing, **FOLDER** : Repeat the tracks in the current folder, **ALL** : Repeat the whole CD (see page 11 for more information)).
8. Alarm, sleep and snooze indicators (see page 14).
9. Displays the name of the radio station or if listening to a CD, displays the track number and elapsed time (see page 11).
10. Displays date, scrolling text, settings and station information. If listening to MP3s on a CD, displays the name of the MP3 file.

Adjusting and muting the volume

Turn the **Volume** dial or press the **Volume** buttons on the remote to increase or decrease the volume. Press the **Volume** dial or press the **Mute** button on the remote to mute.

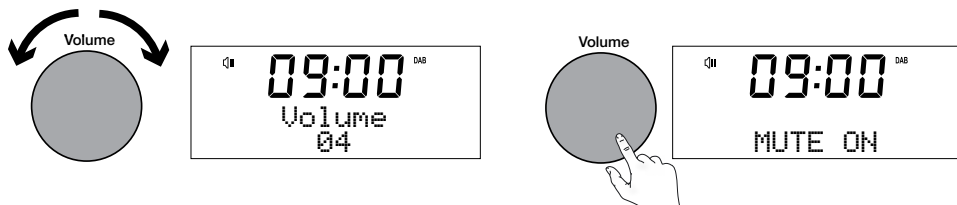

Note: Evoke will automatically go into standby if left in mute for 30 minutes.

Changing source

Use the **Source** button to choose between digital radio, FM radio, auxiliary input, Bluetooth or CD.

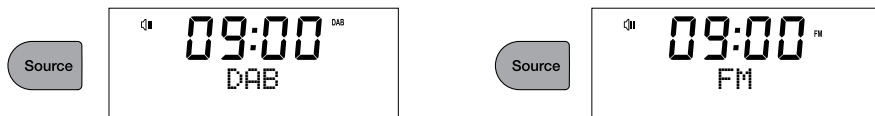

Changing the information shown on screen

When listening to a digital radio station, FM radio station or you are streaming a track from your Bluetooth device, you can change the information that is displayed on Evoke's screen. When listening to an MP3 on a CD, Evoke displays information about the track.

Digital radio

When listening to digital radio, press the **Select** dial to toggle the information displayed on Evoke's screen between 'Scrolling text', 'Signal strength', 'Programme type', 'Ensemble', 'Frequency', 'Signal error', 'Bitrate', 'Time' or 'Date'.

FM radio

When listening to FM radio, press the **Select** dial to toggle the information displayed on Evoke's screen between 'Scrolling text', 'Programme type', 'Date' or 'Frequency'.

Bluetooth

When streaming a track from your Bluetooth device to Evoke, press the **Select** dial to toggle the information displayed on Evoke's screen between 'Track title', 'Album name', 'Artist name', 'Stream format' or 'Play time'.

Getting started

Quick start

- 1 Fit the correct pin connector to the supplied mains power adapter.

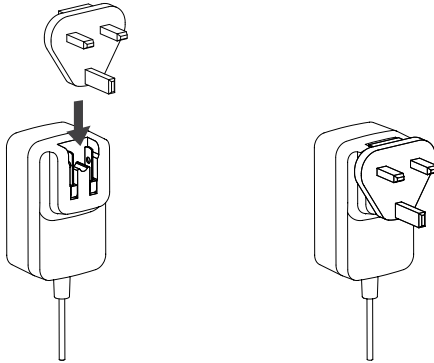

- 2
 - Unclip the aerial and fully extend it (steps **A** and **B**).
 - Insert the jack of the supplied mains adapter into the socket on the rear of the radio (**C**).
 - Plug the mains adapter into the mains supply (**D**).

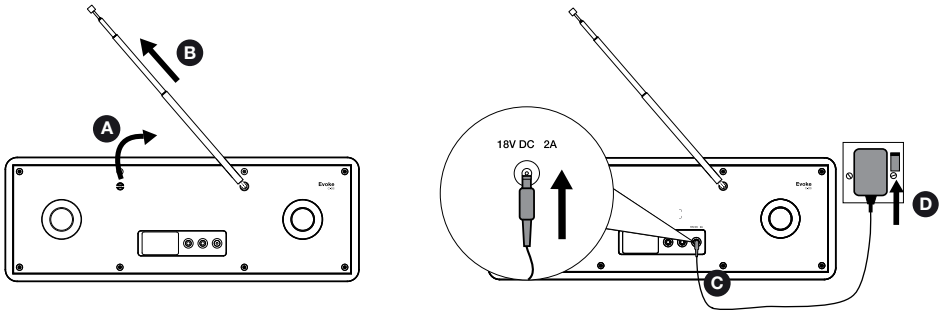

- 3 Wait for your radio to complete an Autotune and find all available digital stations. When the Autotune is complete, a station will start playing.

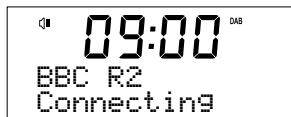

Changing digital radio stations

Using the front panel controls

Turn the **Select** dial left or right to browse through the list of available digital stations. Push the **Select** dial to change the station.

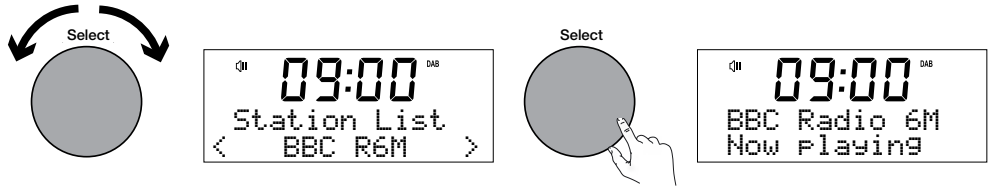

Using the remote control

1. Press the < or > button on the remote to browse through the list of available digital stations.
2. Press the **Select** button to change the station.

Changing FM radio stations

Seek tuning

Press the **Select** dial or the **⏪** or **⏩** buttons on the front panel to seek to the next or previous FM radio station that has a strong signal. If you are using the remote control press the **⏪** or **⏩** buttons on the remote control to seek to the next or previous station.

Manual tuning

Turn the **Select** dial right or left or press the **⏪** or **⏩** buttons on the front panel to step up or down 0.05 MHz. If you are using the remote control press the < or > buttons to step up or down 0.05 MHz.

Storing and selecting presets

Evoke lets you store up to 10 digital and 10 FM radio stations for quick access.

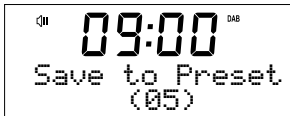

To quick-store a station to a preset button (1-3)

Tune to the digital or FM radio station you want to store. Press and hold one of the numbered Preset buttons (1-3) for two seconds until you see a message to confirm that the preset has been stored on the bottom line.

To store a station to the preset list (4-10)

1. Tune to the digital radio or FM radio station you want to store.
2. Hold the **4+** button to view the numerical list of stored presets, then turn and press the **Select** dial or use the **<Select>** buttons on the remote control to choose any Preset number between 4 and 10. You can overwrite existing presets.
3. Press the **Select** dial or the **Select** button on the remote control to store the preset.

To recall a preset when listening to digital radio or FM radio

1. To tune to Presets 1 to 3, press the corresponding numbered button on the front panel or on the remote control (1 to 3).
2. To access presets 4 to 10 on the front panel press the **4+** button, turn the **Select** dial right or left to scroll through the list of presets, then push and release the **Select** dial to tune to the selected preset. To access presets 4 to 10 using the remote control, press and release the **4+** button and use the **<Select>** buttons to scroll and select a preset.

Playing a CD

Inserting a CD

Insert your CD label side up. When you first insert a CD, Evoke displays 'Reading' for a few seconds while the CD loads. After a few seconds, your CD will start to play automatically.

Playing a track

During audio CD playback, Evoke's display shows the track number and the amount of time the track has been playing. The second line of the display will show the file name if available.

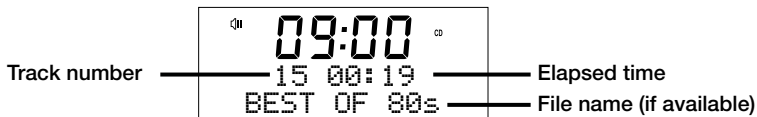

Playback controls

You can use the following controls on the front panel or remote control to control CD playback:

- ▶|| Press to pause the track that is currently playing. If you have paused a track, press to resume playback.
- ⏮ Press to play the previous track.
- ⏭ Press to skip to the next track.
- ⏪ Press and hold to rewind the track that is currently playing.
- ⏩ Press and hold to fast forward the track that is currently playing.
- Press to stop the CD.

Shuffling tracks

You can use the 'CD: Random' setting on Evoke to listen to shuffle the tracks on your CD. To change the 'CD: Random' setting:

1. Press the **Menu** button and turn and press the **Select** dial or use the **<Select>** buttons on the remote control to choose 'CD Menu'.
2. Turn and press the **Select** dial or use the **<Select>** buttons on the remote control to choose 'CD: Random'.
3. Turn and press the **Select** dial or use the **<Select>** buttons on the remote control to choose 'On' if you want to enable track shuffling. Turn and press the **Select** dial or use the **<Select>** buttons on the remote control to choose 'Off' if you want to disable track shuffling.

Repeating tracks

You can use the 'CD: Repeat' setting on Evoke to repeat the track that is currently playing or the entire CD. To change the 'CD: Repeat' setting:

1. Press the **Menu** button and turn and press **Select** dial or use the **<Select>** buttons on the remote control to choose 'CD Menu'.
2. Turn and press the **Select** dial or use the **<Select>** buttons on the remote control to choose 'CD: Repeat'.
3. Turn and press the **Select** dial or use the **<Select>** buttons on the remote control to select one of the following repeat options:

One: Select this option if you want to repeat the track that is currently playing.

All: Select this option if you want to repeat the entire CD.

Off: Select this option if you don't want to repeat any tracks or the entire CD.

Dir: If you have multiple folders on your CD you can select this option to repeat the tracks stored in the folder.

Ejecting a CD

Press the **△** button. Wait until Evoke displays 'Eject' and remove the CD.

Streaming using Bluetooth

You can use Bluetooth to stream any audio from your phone or tablet to Evoke.

Pairing a mobile device with Evoke

Before you can stream audio to Evoke, you will need to pair your phone or tablet with Evoke.

Note: Bluetooth pairing varies on different mobile devices. See your phone or tablet manual for specific information.

1. Press the **Source** button to switch to Bluetooth. Evoke will show 'Bluetooth discoverable' on the display.
2. Enable Bluetooth on your mobile device.
3. On your mobile device, select the option to add a new Bluetooth device. On some mobile devices you may need to select the search or scan option.
4. Start the pairing process on your mobile device. Do this by selecting 'Evoke C-D6' from the list of available devices that appear on the your phone or tablet's screen. If your phone or tablet asks you to enter a key, enter '0000'.

If Evoke has paired to your phone or tablet successfully, Evoke will display 'BT connected: (Bluetooth device name)'.

Disconnecting a mobile device from Evoke

You can only have one phone or tablet connected to Evoke via Bluetooth at any one time. If your mobile device goes out of Evoke's Bluetooth range (this is usually around 10m (30ft)) the mobile device's Bluetooth connection is disconnected automatically. To manually disconnect your mobile device from Evoke, you will need to disconnect from the Bluetooth settings page on your mobile device (see your mobile device's manual for more information).

Using the auxiliary input

You can use Evoke's auxiliary input to play any music from your phone or tablet through Evoke.

Connecting an auxiliary device to Evoke

Connect the line out or headphone socket of your auxiliary device to the Aux In socket on your Evoke using a suitable cable.

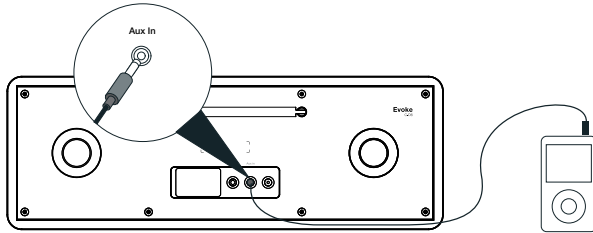

Selecting the auxiliary input



1. Press the **Source** button to switch to auxiliary input (AUX).
2. On your auxiliary device, select the content that you want to listen to on Evoke.

Evoke will start to play the content that you selected on your auxiliary device.

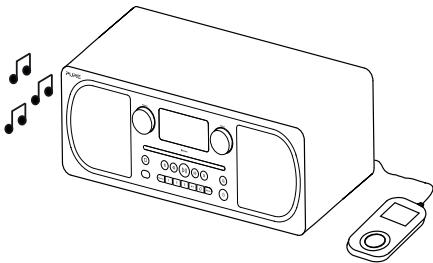

Alarms and timers

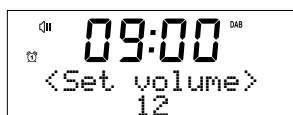
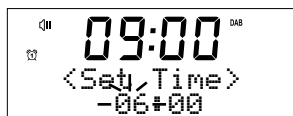
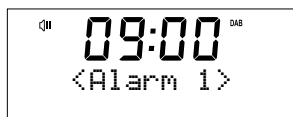

Setting an alarm

Evoko has two alarms which can switch the radio on and tune to a digital or FM radio station, play a CD or sound an alarm tone.

1. Press the **Q** button.
2. Turn and press the **Select** dial to select 'Alarm 1' or 'Alarm 2'.
3. Turn the **Select** dial to scroll through each alarm setting. If you want to change a setting, press the **Select** dial. You can set the following alarm options:

Set alarm: Turn and press the **Select** dial to turn the alarm 'On' or 'Off'.

Set time: Turn and press the **Select** dial to adjust the hour of the alarm. **Note:** If you have set your Evoko to use the 12 hour time format, make sure that you select the 'AM' or 'PM' version of the hour before pressing the **Select** dial. Repeat to set the minutes of the alarm.



Set source: Turn and press the **Select** dial to choose between 'DAB', 'FM', 'Tone' or 'CD'. **Note:** If you select 'CD' as the alarm source and there is no CD in Evoko when the alarm sounds, the 'Tone' will sound instead.

Set station: If you have set your alarm to tune into a digital or FM radio station, turn and press the **Select** dial to choose between the last radio station you were listening to or one of the stations in your preset list.

Set repeat: Turn and press the **Select** dial to choose when you want the alarm to repeat. The available options are 'Once', 'Daily', 'Weekdays' or 'Weekends'.

Set volume: Turn and press the **Select** dial to set the volume of Evoko when the alarm sounds.

Save: Turn and press the **Select** dial to save the alarm.

Evoko's display will show the  or  icon to show that the alarm has been set.

Cancelling a sounding alarm

To cancel a sounding alarm, press any button except the **Select** dial. If you press the **Standby** button during a sounding alarm, Evoko will enter standby.



Snoozing a sounding alarm

To snooze a sounding alarm, press the **Select** dial. Evoke's display will show the  icon and a countdown timer to show how long the alarm will snooze for. By default, Evoke snoozes an alarm for 10 minutes. To change the default snooze time see page 20.

Setting the sleep timer

Evoke has a sleep timer that switches your Evoke into standby after a set time period. To set the sleep timer:

1. Press the **Menu** button.
2. Turn and press the **Select** dial or use the **<Select>** buttons on the remote control to choose 'Sleep timer'.
3. Turn the **Select** dial or use the **<Select>** buttons on the remote control to increase the duration of the sleep timer from 15 to 60 minutes. Press the **Select** dial to start the sleep timer.

Evoke's display will show the  icon when the sleep timer is active.

Options and settings

Digital radio settings

Note: You can only see the digital radio settings when you have selected 'DAB' as the radio source.

Autotune

You can use the autotune function to automatically scan for new digital radio stations and remove inactive ones.

To carry out an autotune:

1. Press the **Menu** button.
2. Turn and press the **Select** dial or use the **<Select>** buttons on the remote control to choose 'DAB Menu'.
3. Turn and press the **Select** dial or use the **<Select>** buttons on the remote control to choose 'Autotune'. The number of stations found will be displayed during the autotune.

When the autotune has finished, Evoke will tune to the last station that you were listening to. If the last station you were listening to is no longer available, Evoke will tune into the first station in the alphabetical list.

Changing the digital radio station order

To change the order that Evoke displays digital radio stations in:

1. Press the **Menu** button.
2. Turn and press the **Select** dial or use the **<Select>** buttons on the remote control to choose 'DAB Menu'.
3. Turn and press the **Select** dial or use the **<Select>** buttons on the remote control to choose 'Station Order'.
4. Turn and press the **Select** dial or use the **<Select>** buttons on the remote control to choose between one of the following options:

Alphanumeric: Choose this option to display digital radio stations in alphanumerical order.

Ensemble: Choose this option to list stations in groups according to their multiplex. Multiplexes or ensembles are groups of stations owned and broadcast by a single operator.

Manual tuning

To manually tune Evoke to a digital radio station that broadcasts on DAB Band III.

1. Press the **Menu** button.
2. Turn and press the **Select** dial or use the **<Select>** buttons on the remote control to choose 'DAB Menu'.
3. Turn and press the **Select** dial or use the **<Select>** buttons on the remote control to choose 'Manual Tune'.
4. Turn and press the **Select** dial or use the **<Select>** buttons on the remote control to choose the channel that the radio station is broadcasting on.
5. Press the **Menu** button to return to the main menu.

Dynamic range control

Dynamic Range Control (DRC) is used to make quieter sounds in a digital radio broadcast easier to hear at low volume or in a noisy environment. Check with the broadcasters to find out if they use DRC.

To change the DRC settings:

1. Press the **Menu** button.
2. Turn and press the **Select** dial or use the **<Select>** buttons on the remote control to choose 'DAB Menu'.
3. Turn and press the **Select** dial or use the **<Select>** buttons on the remote control to choose 'DRC'.
4. Turn and press the **Select** dial or use the **<Select>** buttons on the remote control to choose between one of the following options:

DRC High: Applies maximum compression to the DRC level.

DRC Low: Applies reduced compression to the DRC level.

DRC Off: Removes DRC compression.

Removing inactive digital radio stations from the station list

1. Press the **Menu** button.
2. Turn and press the **Select** dial or use the **<Select>** buttons on the remote control to choose 'DAB Menu'.
3. Turn and press the **Select** dial or use the **<Select>** buttons on the remote control to choose 'Trim'.
4. Turn and press the **Select** dial or use the **<Select>** buttons on the remote control to choose 'Yes'.

Invoke will remove all inactive stations from the station list.

FM radio settings

Note: You can only see the FM radio settings when you have selected 'FM' as the radio source.

FM stereo option

You can choose between the 'Stereo Allowed' or 'Forced Mono' reception setting when listening to FM radio. Mono may improve clarity where stereo signals are weak.

To change between Stereo or Mono reception:

1. Press the **Menu** button.
2. Turn and press the **Select** dial or use the **<Select>** buttons on the remote control to choose 'FM Menu'.
3. Turn and press the **Select** dial or use the **<Select>** buttons on the remote control to choose 'Audio Setting'.
4. Turn and press the **Select** dial or use the **<Select>** buttons on the remote control to choose between 'Stereo Allowed' or 'Forced Mono' reception.

FM scanning mode

You can choose whether Evoke automatically stops at the next available FM station or the next available FM station with a strong signal when scanning for an FM station. To change the FM scan setting:

1. Press the **Menu** button.
2. Turn and press the **Select** dial or use the **<Select>** buttons on the remote control to choose 'FM Menu'.
3. Turn and press the **Select** dial or use the **<Select>** buttons on the remote control to choose 'Scan Setting'.
4. Turn and press the **Select** dial or use the **<Select>** buttons on the remote control to choose between one of the following options:

All Stations: Choose this option to change the scan setting to automatically stop at the next available FM station.

Strong Station: Choose this option to change the scan setting to automatically stop at the next available FM station with a strong signal.

System settings

Carrying out a factory reset

Resetting your Evoke removes all presets, stored stations, alarms and resets all other options to default settings.

1. Press the **Menu** button.
2. Turn and press the **Select** dial to choose 'Settings'.
3. Turn and press the **Select** dial to choose 'Factory reset'.
4. Turn and press the **Select** dial to select 'Yes' to reset Evoke to factory settings. Select 'No' if you do not want to reset your Evoke to factory settings.

Displaying the firmware version

To display the firmware version:

1. Press the **Menu** button.
2. Turn and press the **Select** dial to choose 'Settings'.
3. Turn and press the **Select** dial to choose 'Firmware'.
4. Turn and press the **Select** dial to display the 'DAB' or 'MCU' firmware version.

Changing your preferred language

You can select the language that your Evoke uses for menus and options.

1. Press the **Menu** button.
2. Turn and press the **Select** dial to choose 'Settings'.
3. Turn and press the **Select** dial to choose 'Language'.
4. Turn and press the **Select** dial to select a menu language from 'English', 'Français' (French), 'Deutsch' (German), 'Italiano' (Italian), or 'Español' (Spanish).

Updating Evoke's firmware

Firmware updates for your Evoke may be made available in the future. If you register your product and include a valid e-mail address you will receive notification of firmware updates and information on how to update the firmware for your Evoke (register at account.pure.com). Alternatively, visit <http://support.pure.com> at any time to check for available firmware updates.

Changing the display brightness level

You can adjust the brightness of the display for when Evoke is switched on and in standby. To change the brightness level:

1. Press the **Menu** button.
2. Turn and press the **Select** dial or use the **<Select>** buttons on the remote control to choose 'Brightness'.
3. Turn and press the **Select** dial or use the **<Select>** buttons on the remote control to choose either 'Normal Mode' to change the settings that apply when Evoke is switched on, or 'Standby Mode' to change settings that apply in standby.
4. Turn the **Select** dial or use the **< >** buttons on the remote control to vary the brightness level between 1 (dim) and 5 (bright) and push the **Select** dial or press the **Select** button on the remote control to confirm your preferred setting.

Setting the time and date

The time and date on Evoke are automatically set by the digital radio signal. If the time or date does not update automatically, you can manually set it using this option.

Note: Any time or date updates received by a digital broadcast will override manual settings.

Time and date synchronization options

You can synchronize the time and date on Evoke using either the FM or digital radio signal or you can choose to synchronize the time using both signals.

To specify the clock synchronization options:

1. Press the **Menu** button.
2. Turn and press the **Select** dial or use the **<Select>** buttons on the remote control to choose 'Date/Time Set'.
3. Turn and press the **Select** dial to choose between the 'DAB', 'FM' and 'Both' clock synchronization options.

Setting the time and date manually

1. Press the **Menu** button.
2. Turn and press the **Select** dial or use the **<Select>** buttons on the remote control to choose 'Date/Time Set'.
3. Turn and press the **Select** dial or use the **<Select>** buttons on the remote control to choose 'Manual'.
4. Turn and press the **Select** dial or use the **<Select>** buttons on the remote control to set the hour. Repeat to adjust the minutes.

Note: If you have set your Evoke to use the 12 hour time format, make sure that you select the 'AM' or 'PM' version of the hour before pressing the **Select** dial or **Select** button on the remote control.

5. Turn and press the **Select** dial or use the **<Select>** buttons on the remote control to set the day of the month. Repeat to set the month and year.

Changing the time format

1. Press the **Menu** button.
2. Turn and press the **Select** dial or use the **<Select>** buttons on the remote control to choose 'Time Mode'.
3. Turn and press the **Select** dial or use the **<Select>** buttons on the remote control to choose between '12 Hours' and '24 Hours'.

Changing the alarm snooze time

1. Press the **Menu** button.
2. Turn and press the **Select** dial or use the **<Select>** buttons on the remote control to choose 'Snooze adjust'.
3. Turn and press the **Select** dial to change the snooze time between 1 and 10 minutes.

Choosing an equalisation setting

Evoke includes six equalisation audio presets and also includes a loudness setting to help improve your listening experience when listening to Evoke at a low volume.

Using a predefined equalisation setting

To use a predefined equaliser setting on Evoke:

1. Press the **Menu** button.
2. Turn and press the **Select** dial or use the **<Select>** buttons on the remote control to choose 'Set EQ'.
3. Turn and press the **Select** dial or use the **<Select>** buttons on the remote control to choose between 'Flat', 'Rock', 'Pop', 'Classic', 'Jazz' and 'News'.

Creating a custom equalisation setting

Setting the bass and treble manually

1. Press the **Menu** button.
2. Turn and press the **Select** dial or use the **<Select>** buttons on the remote control to choose 'Set EQ'.
3. Turn and press the **Select** dial or use the **<Select>** buttons on the remote control to choose 'Custom'.
4. Turn and press the **Select** dial or use the **<Select>** buttons on the remote control to choose 'Bass' or 'Treble'.
5. Turn and press the **Select** dial or use the **<Select>** buttons on the remote control to set the level from '-5' (low) to '5' (high).

Switching on Evoke's loudness setting

If listening to Evoke at low volume, you can use the loudness setting to improve your listening experience.

To switch the loudness setting on or off:

1. Press the **Menu** button.
2. Turn and press the **Select** dial or use the **<Select>** buttons on the remote control to choose 'Set EQ'.
3. Turn and press the **Select** dial or use the **<Select>** buttons on the remote control to choose 'Custom'.
4. Turn and press the **Select** dial or use the **<Select>** buttons on the remote control to choose 'Loudness'.
5. Turn and press the **Select** dial or use the **<Select>** buttons on the remote control to turn the loudness setting 'On' or 'Off'.

Choosing a room equalisation setting

Evoke includes two predefined room equalisation settings that lets you optimise your listening experience based on the type of room you have placed Evoke in.

Changing the room equalisation setting



To change the room equaliser setting on Evoke:

1. Press the **Menu** button.
2. Turn and press the **Select** dial or use the **<Select>** buttons on the remote control to choose 'Room EQ'.
3. Turn and press the **Select** dial or use the **<Select>** buttons on the remote control to choose between one of the following room equaliser settings:

EQ1: Choose this option for detailed, clear audio, which is ideal for places like lounges and bedrooms.

EQ2: Choose this option for a slightly softer audio response, which suits places with harder materials and surfaces like kitchens and conservatories.

Technical specifications

Radio	Digital and FM radio
Frequencies	DAB/DAB+, FM radio 87.5-108 MHz
CD player	CD-R and CD-RW playback compatible. Multiple playback modes (repeat, random, etc.).
Bluetooth	Frequency range: 2402-2480 MHz Maximum power: 7.20 dBm (EIRP). A2DP support
Speaker	2 x 3" wide range speakers
Software version	v1.0
Inputs	18V DC power adapter socket (230V supplied), 3.5 mm Aux In for auxiliary devices
Outputs	3.5mm stereo headphone
Presets	10 digital radio and 10 FM radio presets
Mains power adapter	Adapter: Input AC 100 - 240 V~, 50/60 Hz; Output DC 18V  , 2 A; Main unit: DC 18V  , 2 A
Software version	v1.0
Dimensions	135 mm high x 370 mm wide x 223 mm deep
Weight	3.8 kg
Aerial	Captive telescopic aerial
Approvals	 CE marked. Hereby, Pure International Limited declares that this radio model Evoke C-D6 is in compliance with the essential requirements of RED 2014/53/EU. The full text of the EU Declaration of Conformity is available at the following internet address: http://www.pure.com/about/red

Correct disposal of this product



This marking indicates that this product should not be disposed with other household waste throughout the EU. To prevent possible harm to the environment or human health from uncontrolled waste disposal, recycle it responsibly to promote the sustainable reuse of material resources. To return your used device, please use the return and collection system or contact the retailer where the product was purchased. They can take this product for environmental safe recycling.

Copyright

Copyright 2018 by Pure International Limited. All rights reserved. No part of this publication may be copied or distributed, transmitted, transcribed, stored in a retrieval system, or translated into any human or computer language, in any form or by any means, electronic, mechanical, magnetic, manual or otherwise, or disclosed to third parties without the express written permission of Pure International Limited.

Trademarks

Evoke C-D6, Pure and the Pure logo are trademarks or registered trademarks of Pure International Limited. All other product names are trademarks of their respective companies.

Warranty Information

Pure International Limited warrants to the end user that this product will be free from defects in materials and workmanship in the course of normal use for a period of two years from the date of purchase. This guarantee covers breakdowns due to manufacturing or design faults; it does not apply in cases such as accidental damage, however caused, wear and tear, negligence, adjustment, modification or repair not authorised by us. Please visit account.pure.com to register your product with us. Should you have a problem with your unit please contact your supplier or contact Pure Support at the address shown on the rear of this manual.

Disclaimer

Pure International Limited makes no representation or warranties with respect to the content of this document and specifically disclaims any implied warranties of merchantability or fitness for any particular purpose. Further, Pure International Limited reserves the right to revise this publication and to make changes in it from time to time without obligation of Pure International Limited to notify any person or organisation of such revisions or changes.