

Diamond 9 Series

Instruction Manual



9.0

9.1

9.2

9.3

9.4

9.5

9.6

9.CC

9.CS

9.CM

9.SR

9.DFS

SW 150

SW 250

Wharfedale

BRITAIN'S MOST FAMOUS LOUDSPEAKERS

DIAMOND 9 SERIES USER INSTRUCTIONS

IMPORTANT SAFETY INFORMATION

Read these instructions.

Keep these instructions.

Heed all warnings.

Follow all instructions.

Do not use this apparatus near water.

Clean only with dry cloth.

Do not block any ventilation openings.

Install in accordance with the manufacturer's instructions.

Do not install near any heat sources such as radiators, heat registers, stoves, or other apparatus (including amplifiers) that produce heat.

Do not defeat the safety purpose of the polarized or grounding type plug. A polarized plug has two blades with one wider than the other. A grounding type plug has two blades and a third grounding prong. The wider blade or the third prong are provided for your safety. If the provided plug does not fit into your outlet, consult an electrician for replacement of the obsolete outlet.

Protect the power cord from being walked on or pinched, particularly at plugs, convenience receptacles, and the point where they exit from the apparatus.

Use only attachments/accessories specified by the manufacturer.



Use only with a cart, stand, tripod, bracket, or table specified by the manufacturer, or sold with the apparatus. When a cart is used, use caution when moving the cart/apparatus combination to avoid injury from tip-over.

Unplug this apparatus during lightning storms or when unused for long periods of time.

Refer all servicing to qualified service personnel. Servicing is required when the apparatus has been damaged in any way, such as power-supply cord or plug is damaged, liquid has been spilled or objects have fallen into the apparatus, the apparatus has been exposed to rain or moisture, does not operate normally, or has been dropped.

Warning: To reduce the risk of fire or electrical shock, do not expose this product to rain or moisture. The product must not be exposed to dripping and splashing and no object filled with liquids such as a vase of flowers should be placed on the product.

No naked flame sources such as candles should be placed on the product.

Caution: Changes or modifications not expressly approved by the manufacturer could void the user's authority to operate this device.

Warning: The mains power switch for this appliance is located on the rear panel. To permit free access to this switch, the apparatus must be located in an open area without any obstructions.

NOTE: This equipment has been tested and found to comply with the limits for a Class B digital device, pursuant to part 15 of the FCC Rules. These limits are designed to provide reasonable protection against harmful interference in a residential installation. This equipment generates, uses and can radiate radio frequency energy and, if not installed and used in accordance with the instructions, may cause

harmful interference to radio communications. However, there is no guarantee that interference will not occur in a particular installation. If this equipment does cause harmful interference to radio or television reception, which can be determined by turning the equipment off and on, the user is encouraged to try to correct the interference by one or more of the following measures:

- Reorient or relocate the receiving antenna.
- Increase the separation between the equipment and receiver.
- Connect the equipment into an outlet on a circuit different from that to which the receiver is connected.
- Consult the dealer or an experienced radio/TV technician for help.



This symbol indicates that there are important operating and maintenance instructions in the literature accompanying this unit.



This symbol indicates that dangerous voltage constituting a risk of electric shock is present within this unit.

ESSENTIAL INFORMATION FOR UK USERS

The power cord on your subwoofer may be supplied with a plug incorporating a fuse, the value of which is indicated on the pin face of the plug. Should the fuse need to be replaced, an ASTA or BSI approved BS1362 fuse must be used of the same rating. If the plug is cut off it must NOT be re-used. Dispose of any such plug safely. There is a danger of electric shock if a cut-off plug is inserted into a mains socket.

The wires in the mains lead are coloured in accordance with the following code: Green and Yellow - Earth: Blue - Neutral: Brown - Live.

As the colours of the wires in the mains lead may not correspond with the markings identifying the terminals in the replacement mains plug, proceed as follows:

The wire coloured Blue must be connected to the terminal marked with the letter 'N' or coloured Black. The wire coloured Brown must be connected to the terminal marked with the letter 'L' or coloured Red. The wire coloured Green and Yellow must be connected to the terminal marked with the letter 'E', or coloured Green, or Green and Yellow, or marked with the Earth symbol \oplus

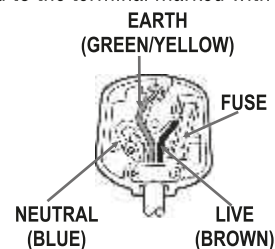

GENERAL GUIDANCE

DO NOT connect the mains power to any signal input terminal.

DO NOT change any connections without first switching off the power to all the components in your AV system. ALWAYS turn down the system master volume control before turning the equipment on or off.

DO NOT use your amplifier at its maximum volume setting. The resulting distortion may damage your loudspeakers and subwoofer. The position of the Volume Control on your amplifier is NOT a reliable guide as to 'how

loud' your equipment will play. Allow your system ample 'headroom'.

Do not operate your subwoofer closer than 450mm from the TV to avoid distorting the colour picture. If this occurs, switch the TV set off. After 15 minutes switch on again: colour balance should now be restored.

To minimise hum and mains interference ensure that low level (line level) signal cables are well screened. Avoid routing low-level signal cables close to or parallel with mains power wiring.

PRELIMINARIES

Unpacking the Speakers

Carefully remove each loudspeaker from its packing carton. Be especially careful when removing the polythene bag. DO NOT attempt to lift the loudspeaker by the polythene bag.

Retain the packing for future use. If you decide to dispose of the packing, please do so with regard to any recycling regulations in your area.

Retain the instructions. If you pass a product to a third party, please include the instructions.

Fitting the Plinth and Spikes (Models 9.4, 9.5, 9.6 only)

Carefully invert each loudspeaker. Protect the top surface from scratches or damage when the loudspeaker is in the inverted position.

Each loudspeaker is provided with four spikes. Prepare the spikes as shown and screw the spikes into the threads on the plinth. Return the loudspeaker to its normal position taking care not to cause damage with the spikes.

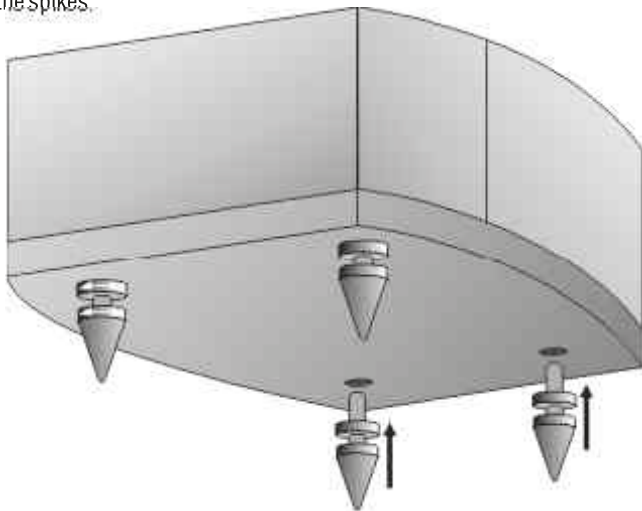

When moving speakers, be careful not to let the spikes pierce objects or cables which may be concealed under the carpet. Never drag loudspeakers. If you cannot lift them easily, get someone to assist you

Adjusting the Spikes: Loosen the nut. Screw each spike in or out so that the speakers are stable. The top surfaces of each loudspeaker should be level and the speakers should be the same height above the floor.

When the speakers are in their final positions, tighten all the nuts.



Stands and Brackets

The 9.1, 9.2, and 9.3 are intended primarily for stand mounting, though they can be mounted on wall brackets or even on sturdy shelves. The quality of loudspeaker stands greatly influences the performance of your loudspeakers so do not use flimsy products.

The Diamond 9.0 may be stand or wall mounted. The rear panel has a threaded insert for attaching a pair of suitable wall brackets.

Centre Channel Loudspeakers

Each centre channel loudspeaker is supplied with two sets of mounting feet. By using a combination of large and small feet the loudspeaker may be angled to point directly at the listening position. This will be found useful when the centre speaker is positioned under the TV screen.

Surround Loudspeakers

These speakers are designed primarily for wall mounting, though they may be stand or shelf mounted if required. Please see Page 5

Crossover Networks

Most speakers in the Diamond 9 series use a specially designed bi-wireable crossover panel with four terminal binding posts. Please follow the drawing carefully to see the correct orientation of the loudspeaker terminals. The upper terminals connect to the treble unit, the lower pair to the bass unit. As supplied, the treble terminal pair is connected to the bass terminal pair via removable metal straps. These should be left in place for standard installations.

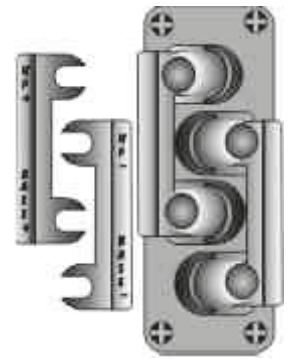

The D9.0 compact monitor, the D9.CC compact Centre Channel speaker and the D9.SR use essentially the same circular section crossover panel. These are illustrated below.

The D9 DFS uses a crossover network panel built into the speaker's rear wall. This is illustrated on Page 4.

None of the abovementioned loudspeakers are bi-wireable.

D9.SR



D9.0 & D9.CC



Choosing and Preparing Cables

Specialist audio cable offers better performance than general purpose 'bell' or 'zip' wire.

Choose a cable of suitable diameter - cable that is too thin will limit the dynamics of the sound and may impair the bass response. Audio cable is polarised, with two cores of different colours, or often a raised rib or coloured tracer in the case of twin cable.

Split the twin cores to a depth of about 40mm. Carefully strip the insulation from each end, leaving about 10mm of bare wire. If the cable is stranded, lightly twist to gather any loose strands.

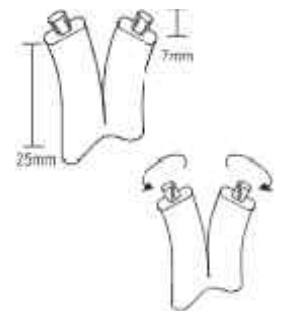

Connecting Terminals

Unscrew the terminal. Thread the bared end of each cable through the hole in the bottom of the terminal post. Ensure that there are no loose strands which may touch adjacent terminals. Re-tighten the terminal securely. The drawing on the right illustrates the method.

NOTE: When connecting loudspeakers, the cables to left and right channels should ideally be of equal length, regardless of the distance of the speakers from the amplifier.

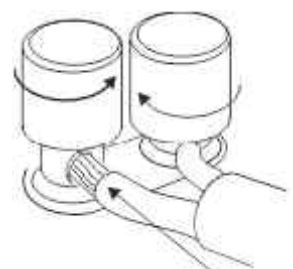

FRONT LOUDSPEAKER CONNECTIONS

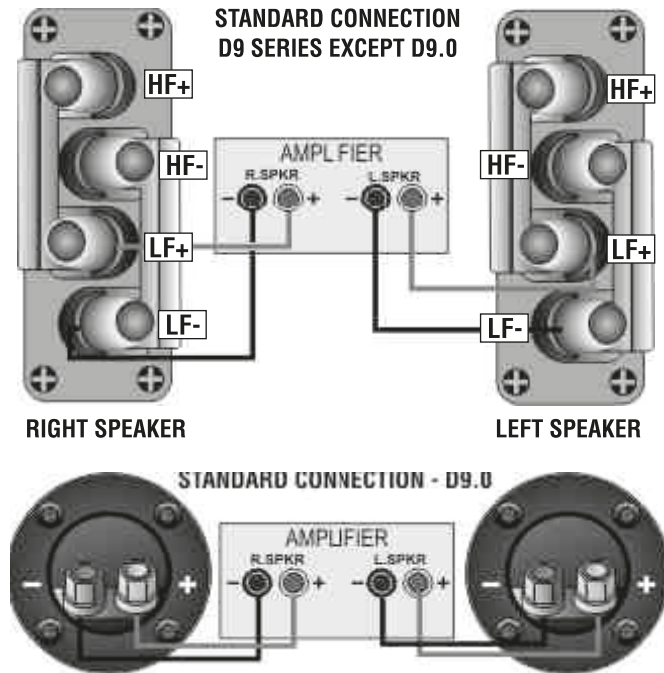

Choose a suitable length of twin core speaker cable for each channel, and prepare the ends. Unscrew each terminal a few turns.

Connect the red, positive (+) terminal of the Left loudspeaker to the corresponding red, positive (+) amplifier terminal. Connect the black, negative (-) terminals similarly. Tighten the terminals securely. Repeat this procedure for the Right Channel.

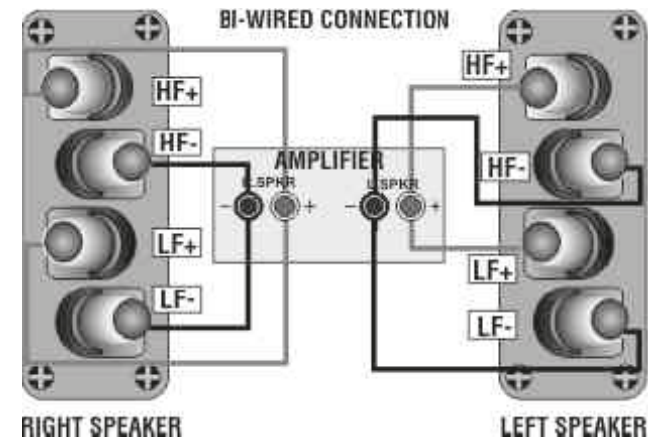

Using separate cables for treble and bass units in a Bi-Wiring configuration reduces intermodulation effects and improves headroom and clarity. To bi-wire, you will need to install two equal lengths of twin core cable between the amplifier and each loudspeaker.

Unscrew each terminal a few turns and remove the metal straps. Connect the cables between the amplifier and the loudspeakers as indicated above and re-tighten all the terminals securely.

Note: Some amplifiers have two pairs of output terminals to facilitate bi-wiring but this is not essential. The advantages of bi-wiring are fully retained if your amplifier has one pair of output terminals per channel

Bi-Amplifying (Bi-Amping)

By connecting each loudspeaker drive unit to its own dedicated amplifier the advantages of Bi-Wiring can be extended. If you own two identical stereo power amplifiers, your speakers may be Bi-Amped. For further details please consult your dealer.

CENTRE CHANNEL AND SURROUND LOUDSPEAKERS

Connect these speakers as shown below. The Centre channel speaker may be connected as shown, or bi-wired.

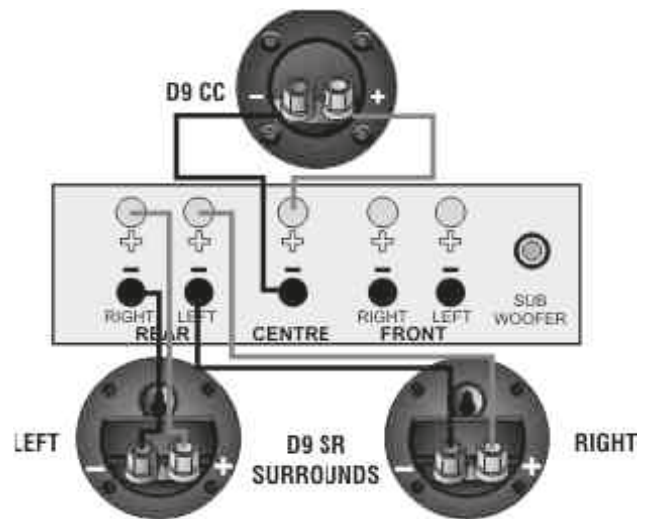
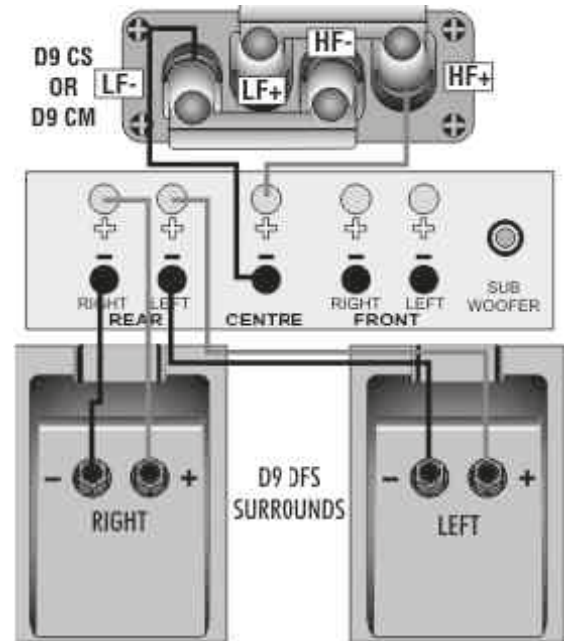

Positioning the Front (stereo) Loudspeakers

The 9.4, 9.5 and 9.6 are designed to be floor standing. We suggest that they are positioned at least 200 mm from the rear walls and 700 mm from the side walls, facing slightly inwards. The 9.1, 9.2, and 9.3 should ideally be stand or wall mounted though they may be placed on a rigid shelf. The 9.0 can be stand or wall mounted. The bass extension will improve if these smaller speakers are operated closer to the rear walls.

If the loudspeakers are placed too close to the walls the bass will increase but may be boomy and indistinct. If the loudspeakers are placed away from the walls, the inward angle may be increased by up to 40%, although this may restrict the width of the optimum listening position.

A useful rule of thumb is that the listener should be as far from the loudspeakers as they are from each other. The speakers should ideally be positioned so that the treble units are roughly at ear level to a seated listener. As personal taste plays a large role, experiment with different configurations and play a wide range of programmes before finalising the position of your speakers.

Positioning the Front Loudspeakers (...cont. from page 4)

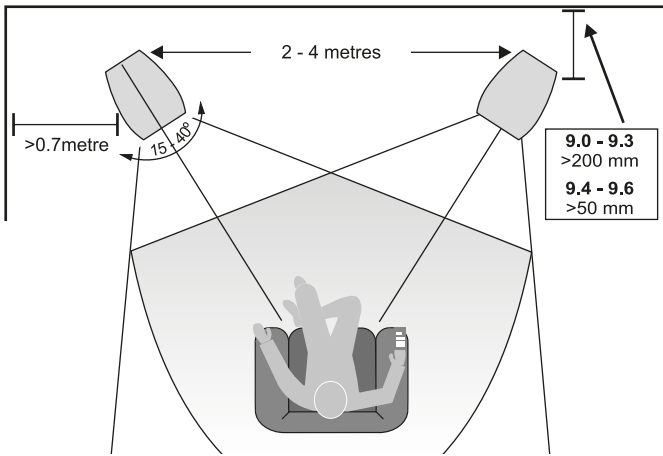

Centre Loudspeaker

The Centre channel loudspeaker should be positioned centrally between the loudspeakers, close to the television and mounted above or below the screen.

The loudspeaker should be located on a stable flat surface to avoid any cabinet movement at high sound levels. If you mount the unit on top of the television, move it forward so that the front grille sits slightly in front of the screen. This will reduce sound reflections from the screen and the top of the cabinet.

The D9 CS and the D9 CM are supplied fitted with mounting feet which support the cabinet in a horizontal position. Four extra feet are supplied to enable you to tilt the cabinet up or down so that the speaker points directly at the listening position. This facility is particularly useful where the Centre speaker is mounted under the screen.



NOTE: All Diamond 9 bookshelf and floorstanding loudspeakers are

magnetically shielded so they may be positioned close to TV screens and monitors with no ill-effects or colour distortion.

D9 DFS Surround Loudspeakers

The speakers should ideally be sited 600 mm-1.5 metres above the listening position and 2.5-3.5 metres apart, central to the listener and behind the listening position, preferably on a rear wall. If the listening position is some distance from a rear wall, the speakers may be mounted on opposite side walls but **always** behind the listening position.

Ensure that the wall is sound and can support the product. Drill two 5mm holes in the wall 220mm apart. Fix a suitable No 8 round head screw firmly into each hole using appropriate wall plugs. Leave a stub of 5mm protruding from the wall.

Connect the loudspeakers. Align the holes in the mounting brackets over the screw and carefully lower the unit onto the screws. The speaker should now be securely attached with the spacers resting against the wall. Now connect the speakers to the amplifier.

Note: As an alternative, the D9 DFS can be shelf or stand mounted. The badge on the D9 DFS can be rotated to match the orientation of the loudspeaker.

D9 SR Surround Loudspeakers

Before mounting the loudspeakers, establish the location using the same criteria as for the D9 DFS. Ensure the wall is sound and can easily support the weight of the loudspeakers.

The D9 SR is supplied with four mounting feet for shelf or stand mounting. In addition the terminal panel has a built in mounting slot for wall fixing.

Wall mounting the D9 SR: Ensure the wall is sound and can easily support the weight of the loudspeakers. Drill and fix a No. 8 screw and suitable wall plug at each chosen location. The screw should protrude about 5mm from the wall. Connect the cable to the speaker. Align the keyhole slot over the screw. Pull gently down to secure the speaker.

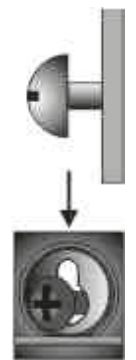
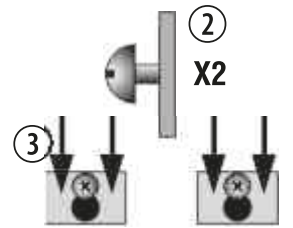
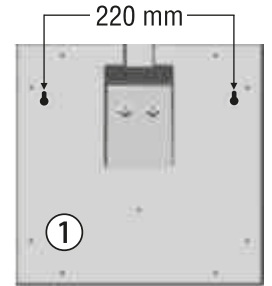

THE HOME CINEMA ENVIRONMENT

The diagrams below illustrate some typical Home Cinema room layouts.

System with D9 SR Surround Speakers

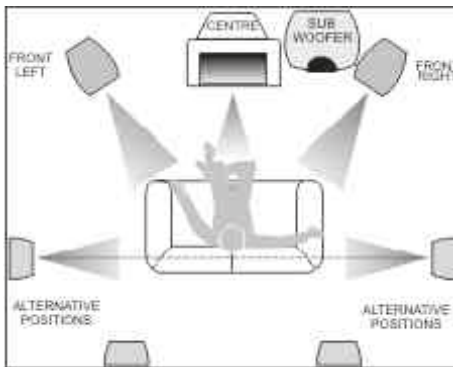

System with Rear Mounted D9 DFS Surrounds

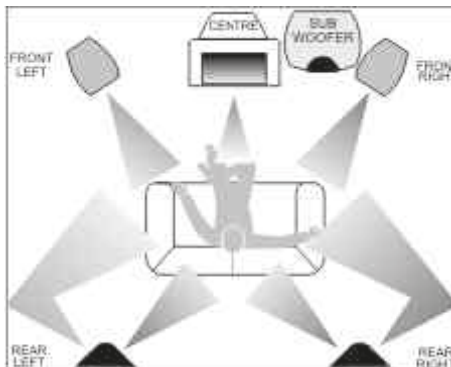

System with Side Mounted D9 DFS Surrounds

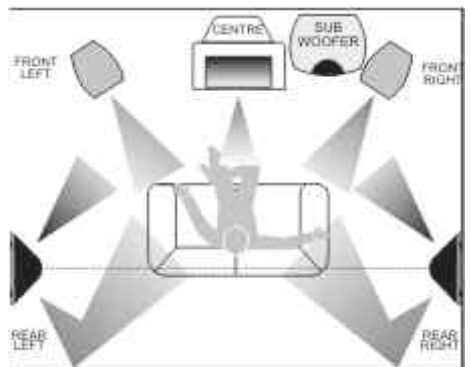

HOME CINEMA SETUP

Front And Effects Channels

The front loudspeakers are placed on either side of the television screen, 2 to 3 metres apart. The speakers should be angled slightly so they are aimed towards the listeners.

As the rear surround channels are the 'effects' channels the reproduced sound should be as room filling as possible. We recommend placing the speakers in a high position, behind the listener's head. If the rear wall is more than 1 metre behind the listening seat, position the units on the side walls. If the walls are a long way from the listening seat, consider stand mounting the loudspeakers.

Most of the dialogue comes from the centre loudspeaker. Speech should appear to originate from the actors' mouths. Operating height is important. Ideally the front and centre channel speakers should be at the same height. For this reason the centre channel speaker is best operated on top of the television monitor. The front faces of the centre and surround loudspeakers should also be in line as far as possible.

Subwoofer

As the ear is unable to detect the direction from which deep bass originates, this allows you freedom to position the unit. Varying the distance from the wall alters the bass. Placing the subwoofer across a corner boosts the bass but may impair clarity.

The performance of Home Theatre systems can often be enhanced by using a pair of subwoofers.

Setting Loudspeaker Sizes

Many digital AV Processors require you to specify the size of speakers in all channels. These are usually 'Large' or 'Small'.

The D9 CM centre channel speaker should be set to 'LARGE'. The other centre channel speakers and the surround channel speakers should be set to 'SMALL' whether you are using a subwoofer or not.

If you are not using a subwoofer: Set the Front Speakers to 'Large'. Set the 'Subwoofer' option on the processor to 'Off' or 'No'. The Front channels will now receive all the system bass.

If you are using a subwoofer: When set to 'Small' all the system bass will go into the subwoofer. If you choose 'Large' the Front channel bass will be reproduced from the Front speakers. Bookshelf speakers should be set to 'Small', large floor standing units may be set to 'Large'.

Setting Levels

Once the loudspeaker settings have been finalised, put the AV amplifier into its "Test" mode (see instructions supplied with your processor). Adjust the level of each channel in turn until all channels are reproduced at equal loudness.

On some programme material the surround channel may seem lower than the front. Do not readjust this level. You may, however, need to adjust the subwoofer output level. Avoid setting too high a level or you will swamp the sound with bass which is tiring to listen to and may limit the subwoofer's ability to respond to large bass transients. You should also set a sensible level going into the subwoofer from the AV processor.

Delay Settings

Many AV processors feature delay settings. The purpose of delay is to enable surround and dialogue information to arrive at the listener's ears at the same time as the Front channels, even when the listening seat is in a non-ideal position.

Rear Delay: If the listening position is equidistant from the Front and Rear speakers, a low delay setting should be set. The closer the listener is to the Rear speakers the higher should be the delay setting used,

Centre Delay: If the Centre speaker is level with (or slightly behind) the Front speakers, set the delay to zero. If the Centre speaker is forward of the Front speakers, increase the delay.

LFE

In the cinema the Low Frequency Effects channel is an extra bass channel with its own subwoofer and not a regular subwoofer channel. In domestic systems the LFE channel typically feeds into the subwoofer. Where no subwoofer is used, the LFE signal is combined with Front Channel information. When you set the LFE level at your AV processor, use care as the powerful low frequencies can overload domestic loudspeakers.

If you hear popping or thumping noises coming from the front loudspeakers or subwoofer, immediately turn the AV Processor's volume level down and then back off the LFE level. This should cure the problem. If it does not, back off the volume level at the subwoofer (if you are using one) until the problem disappears.

Please read the relevant sections of your AV amplifier manual and familiarise yourself with the various issues. If you are unsure, consult your dealer for help.

DIAMOND SW 150 USER INSTRUCTIONS

PRELIMINARIES

Open the carton and remove all the top packing pieces. Lift the subwoofer out taking care not to damage the cabinet. When lifting the unit from the carton support it from the bottom. DO NOT attempt to lift the subwoofer out of the carton using the polythene bag. The unit is heavy; if you cannot manage it easily, get someone to assist you.

Retain the packing materials for future use or return them to your dealer. If you decide not to keep the packing, please dispose of it having regard to any recycling regulations in your area.

Please retain the user manual and the purchase receipt for future reference. If you transfer this equipment to a third party, please ensure all the instructions are passed on with the product.

Power Connections

This subwoofer is factory set to operate from the mains voltage marked on the amplifier panel. Before connecting check this voltage is correct for your mains supply.

- 230 volt products - 220 volts to 240 volts
- 115 volt products - 110 volts to 120 volts

If you move to an area with a different mains supply, consult your Wharfedale dealer for advice.

REAR PANEL CONNECTIONS

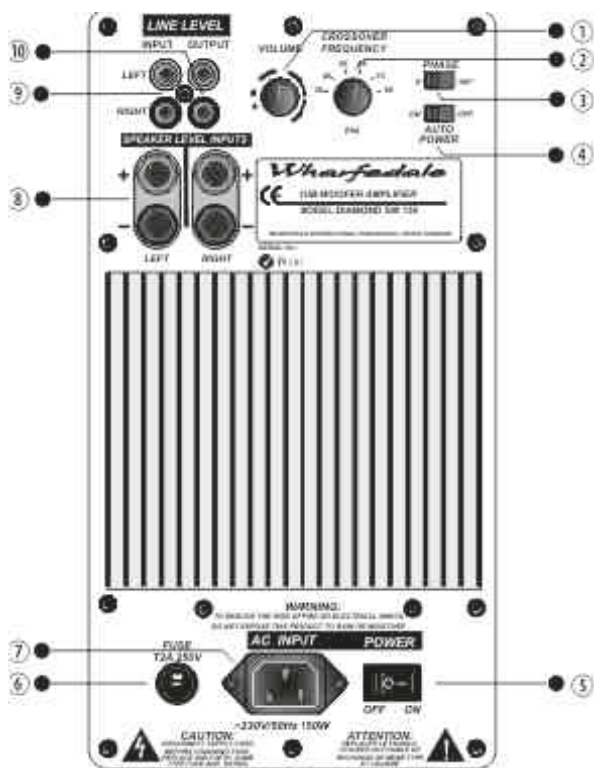

CONTROL PANEL GUIDE

- | | |
|-------------------------------|--------------------------|
| ① Volume Control | ⑥ Mains Power Fuse |
| ② Crossover Frequency Control | ⑦ IEC Mains Input Socket |
| ③ Phase Control | ⑧ Speaker Level Inputs |
| ④ Auto Power Switch | ⑨ Line Level Inputs |
| ⑤ Power ON/OFF Switch | ⑩ Line Level Outputs |

CONNECTING THE SW 150

Line Connections to an A/V Processor

Your subwoofer has been designed for optimum performance with a Digital processor. If your AV processor has a line level or LFE subwoofer output you should use this connection. You will need to purchase a single screened RCA phono lead from your dealer. Connect this lead to the Left line input of the Subwoofer as shown below.

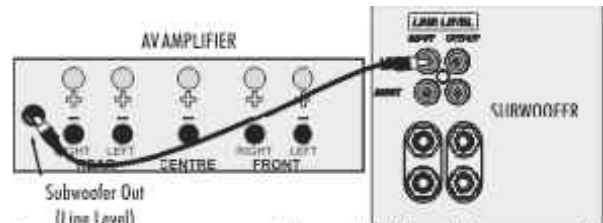

Alternatively, you may use a split mono lead from the processor to both inputs of the subwoofer. In this case the input level at the subwoofer will be slightly higher.

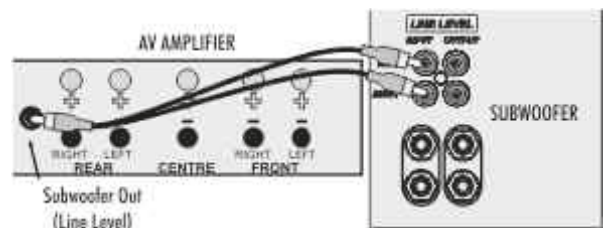

Stereo Line Output Connections

If your amplifier has a spare preamplifier output or a stereo sub-woofer output, connect the sub-woofer as shown. You will need a stereo screened RCA phono cable.

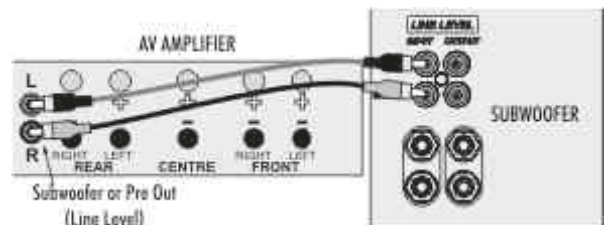

Pre Out - Main In Connections for Stereo Amplifiers

If you use a stereo pre and power amplifier, or a stereo amplifier where the pre and main amplifier can be separated, connect the sub-woofer as shown. There are two alternative methods.

A: You will need two screened RCA 'Y' adaptors and two single RCA phono cables.

Remove the Pre-Main links on your amplifier. Connect the socket (common) of an RCA 'Y' adaptor to one of the mono cables. Connect one leg of the 'Y' adaptor to the Left Channel Pre Out socket on the amplifier and the other leg to the Left Channel Main In socket. Connect the remaining plug on this combination to the Left Channel Line Level Input on the sub-woofer. Repeat this for the Right Channel.

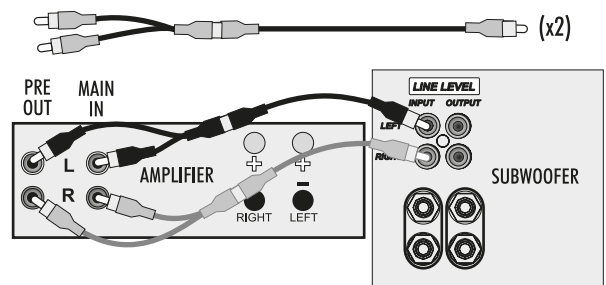

B: You will need two stereo (or four single) screened RCA cables.

Connect a Stereo cable from the Line Level Inputs of the sub-woofer to the Pre Out sockets of the amplifier. Now connect a second Stereo cable from the Line Level Outputs of the sub-woofer to the Main In sockets of the amplifier. The sub-woofer is now inserted within the system loop.

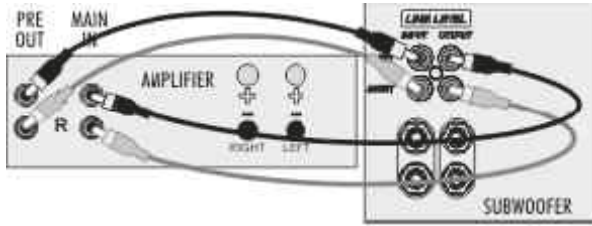

Speaker Level Connections

The high level Speaker connections should be used only if your amplifier does not have a line level subwoofer output. In this connection the subwoofer is fed together with the Front loudspeakers. For this you will need two extra twin core cables.

Choose a good quality audio speaker cable of reasonable size. Avoid using cheap 'bell' or 'zip' cables. Audio speaker cable has a polarity stripe or rib along one conductor to simplify connecting your speakers.



Split the cable at each end to a depth of 30mm. Strip about 7mm of insulation from each end and lightly twist to gather the wire strands.



The Speaker Level connectors are screw terminals located on the control panel. Unscrew a terminal and insert the cable into the hole at the base. Re-tighten the terminal securely. Make sure that the terminal grips the bare wire and there are no loose strands which could touch adjacent terminals.

There are two methods of connecting the subwoofer.

A: Using one of the additional twin core cables, connect the Left Speaker Terminals on the sub bass unit to the Front Left speaker terminals on the amplifier. Connect the Red (+) speaker terminal on the amplifier to the Red (+) terminal on the subwoofer. Connect the Black (-) speaker terminal on the amplifier to the Black (-) terminal on the subwoofer. Now connect the Right Speaker terminals on the subwoofer to the Front Right speaker terminals of the amplifier.

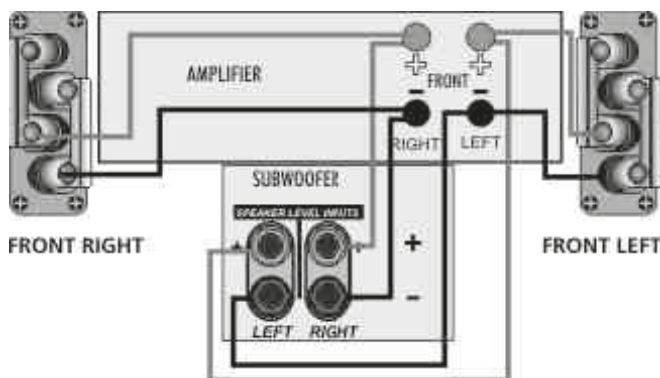

When routing any cables to loudspeakers do not run them across open floor spaces where they may cause danger to people and pets. Route them safely, around room boundaries if necessary.

B As an alternative you may connect the subwoofer to the Front speakers instead of to the amplifier.

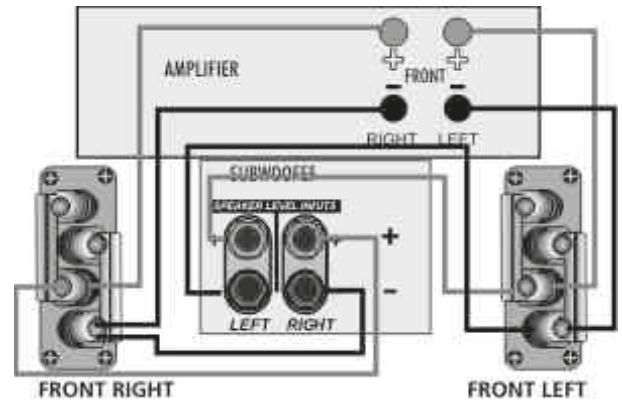

If your speakers are bi-wired: You should ensure that you connect the subwoofer to the BASS terminals ONLY.

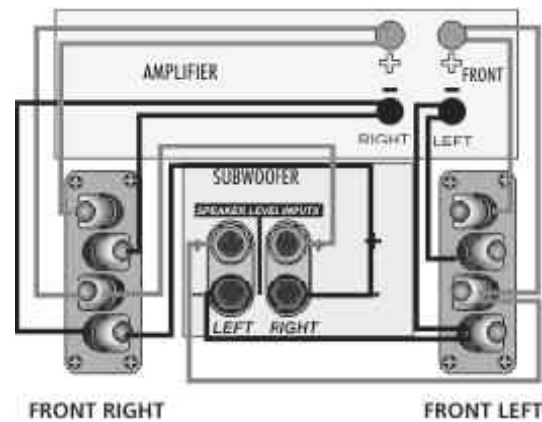

OPERATION

Positioning the Unit

Although the unit may be placed almost anywhere in the room, even behind the sofa or the TV set, we recommend that it be placed in front of the listener and as central to the listening position as possible. The subwoofer should not be operated within 450mm of a television set as the drive unit magnet may distort the picture.

We suggest you position the subwoofer about 20cm (8 inches) from the wall. A position close to the wall will enhance the bass; placing it across a room corner will increase the bass further, possibly at the expense of clarity. Experiment with a variety of locations and sources before making a final decision. Ensure there is a mains outlet within easy reach.

The bass port is mounted underneath the subwoofer and moves a lot of air at high volume, so make sure the floor is sound. The subwoofer is front-firing so do not place it behind surfaces or objects that may rattle.

Your system will perform best if there is a clear line of sight between the subwoofer and the listening position.

SETTING UP

- Set the subwoofer power switch to OFF.
- Turn the system Volume Control to minimum.
- Re-check all system connections.
- Connect the supplied subwoofer power lead to the IEC power socket on the subwoofer and connect the mains plug into the wall socket.
- Switch on the mains power.
- Set the subwoofer volume control to the mid position (12 o'clock) before proceeding.

Fine Tuning

Switch on the subwoofer power switch and check that the power indicator on the front of the cabinet glows. Now switch on the system. Play a programme with extended bass and set the system volume to a reasonable level. Adjust the subwoofer volume control to produce the desired level of bass. Do not overdo things!

PHASE SWITCH: If the bass is indistinct or lacks depth, the Phase switch may need adjustment. Set the switch to 0° and listen carefully to some music with extended bass. If there is insufficient bass output from the sub-woofer set the Phase switch to 180°. Select the position which produces the most natural, extended bass.

LOW PASS FILTER ADJUSTMENT. This adjusts the blend between the subwoofer and the main speakers, and enables the system to be set up for optimum bass performance. The higher settings are for use with small bookshelf loudspeakers, the lower settings for large floorstanding models. If you choose too low a setting with small speakers, there will be a 'hole' in the bass response; too high a setting with large speakers will result in the upper bass becoming bloated.

AUTO SWITCH. In normal mode the subwoofer is permanently on. This may result in low level hum or noise from the subwoofer if the rest of the system is switched off and the subwoofer is left switched on. Setting the AUTO switch to ON will automatically turn the subwoofer on when a signal is detected at any of the inputs and turn it off (Standby Mode) after a period of inactivity. We recommend that the AUTO switch be set to ON for normal operation.

In AUTO mode the indicator on the front of the subwoofer will glow RED when the unit is in Standby mode and GREEN when operational. If your subwoofer is disconnected from the mains power, or the Power switch is "Off", the indicator will be extinguished.

When the system is not in use for extended periods, we suggest you switch off the subwoofer to protect it from switching noises caused by domestic appliances, etc.

Always turn the main volume control to minimum when you switch the system on or off.

THE HOME THEATRE ENVIRONMENT

As the ear is unable to detect the direction from which deep bass originates, this allows freedom in positioning the subwoofer. Varying the distance from the wall will alter the amount of bass. Some prefer to place the subwoofer against a corner of the room. This arrangement gives more bass at the possible expense of clarity.

Loudspeaker Sizes

Many digital AV Processors require you to specify the size of speakers in the various channels. These are usually 'Large' or 'Small'. Unless your loudspeakers are large floor standing units, choose 'Small' for the Front channels, as the subwoofer will be better at providing clean, deep and louder bass. Choose 'Small' for the other channels so that bass from these channels will be directed to the subwoofer. Set the 'Subwoofer' option on the processor to 'On' or 'Yes'.

Setting Levels

Once the loudspeaker settings have been finalised, put the AV amplifier into its "Test" mode (see instructions supplied with your processor.) Adjust the levels until all channels are reproduced at equal loudness.

You may need to adjust the subwoofer output level. Avoid setting too high a level or you will swamp the sound with bass which be tiring to listen to and may limit the subwoofer's ability to respond to large bass transients. Set a sensible level going into the subwoofer. The subwoofer volume control should be between 12 o'clock and 3 o'clock.

LFE

The Low Frequency Effects channel was designed as an additional bass

channel with its own dedicated subwoofer. In practice however, if all the speakers are set to Small, the LFE channel will be combined with the bass from other channels and all this feeds into the subwoofer. When you set the LFE level from your AV processor, use care with this setting as the LFE channel may contain powerful low frequencies which, although normal in a cinema, may overload a domestic subwoofer.

If, during a programme, you hear popping or thumping noises coming from the subwoofer, immediately turn the AV Processor's volume level down and then back off the LFE level. If this does not cure the problem, back off the volume level at the subwoofer.

Please read the relevant sections of your AV amplifier manual and familiarise yourself with the various issues. If you are unsure, consult your dealer for help.

SETTING UP TWO SUBWOOFERS

Two subwoofers offers considerable advantages. Points to note are:

- A well-sited pair of subwoofers for stereo applications will be adequately sited for Home Cinema applications.
- A second subwoofer raises the bass output level 6dB when operating in Home Cinema but *not* in Stereo.

HOME CINEMA: Although AV processors have one subwoofer channel, properly spaced subwoofers help to fill in troughs caused by standing waves, smoothing the bass and giving it greater intensity.

STEREO: Each subwoofer should be located as near as possible to its partnering loudspeaker. The smaller the main speakers, the more necessary this becomes.

CONNECTING TWO SUBWOOFERS

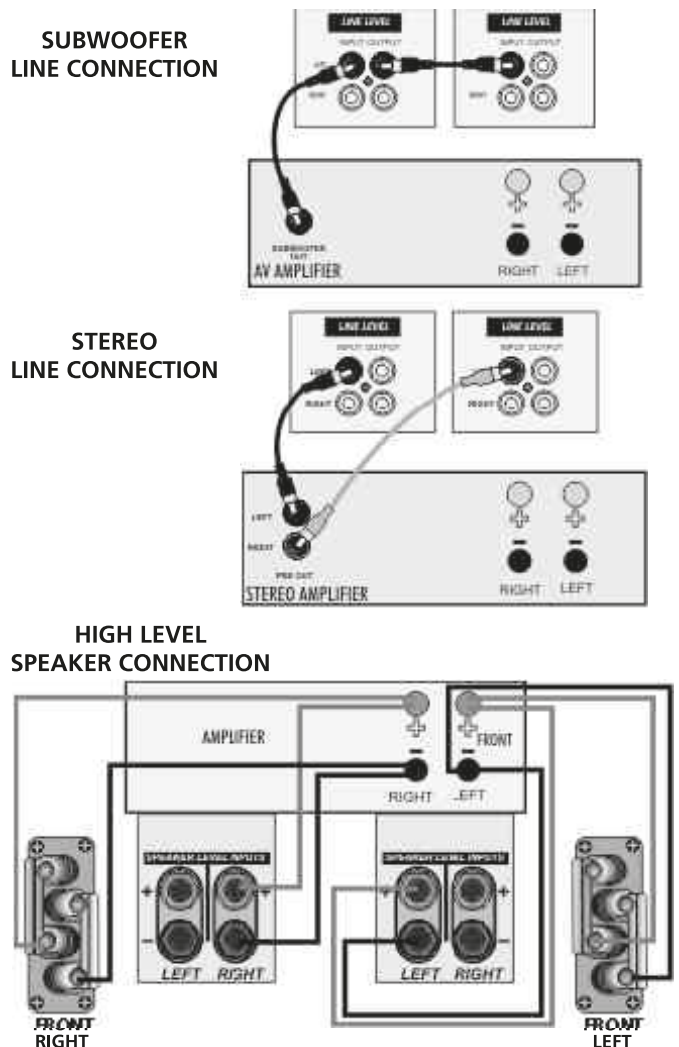

DIAMOND SW 250 USER INSTRUCTIONS

PRELIMINARIES

Open the carton and remove all the top packing pieces. Lift the subwoofer out taking care not to damage the cabinet. When lifting the unit from the carton support it from the bottom. DO NOT attempt to lift the subwoofer out of the carton using the polythene bag. The unit is heavy; if you cannot manage it easily, get someone to assist you.

Retain the packing materials for future use or return them to your dealer. If you decide not to keep the packing, please dispose of it having regard to any recycling regulations in your area.

Please retain the user manual and the purchase receipt for future reference. If you transfer this equipment to a third party, please ensure all the instructions are passed on with the product.

FITTING THE FEET

Carefully invert the subwoofer. Protect the top by placing it on a soft surface such as a towel. Open the polythene bag and slide it part-way down the cabinet. Two sets of adjustable screw feet are provided - regular and spiked. Choose one set only - do not use a mixture of spiked and regular feet.

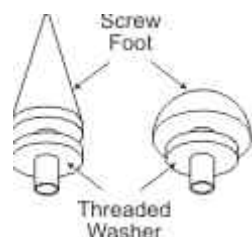

Screw the threaded washer over each foot as shown. Screw a foot part-way into the threaded hole at the bottom of each leg of the subwoofer and hand-tighten the washer. When all four screw feet have been fitted, stand the subwoofer upright and remove the bag.

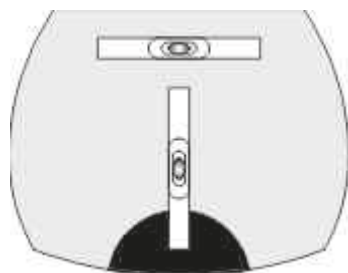
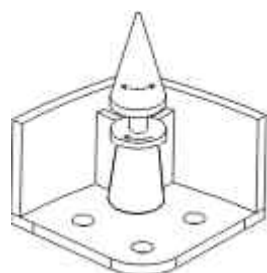

With the aid of a spirit level, screw each foot in and out until the subwoofer is level (side to side and front to back) and firmly supported on all four feet.

Tighten the washer with a wrench to lock the assembly in position.

Note: When using spiked feet take care not to drag the subwoofer and be careful not to pierce objects or cables which may be hidden under carpets, etc. Spikes are not suitable for use with stone floors and can cause damage to wood floors, so consider carefully before deciding which feet to use.

INSTALLATION

Positioning the subwoofer

Although the unit may be placed almost anywhere in the room, we recommend that it is placed in front of the listener central to the listening position. There should be a mains outlet within easy reach. There should be a line of sight between the listener and the front of the subwoofer otherwise the remote functions will not work.

We suggest you initially position the subwoofer about 20cm (8 inches) from the wall. Placing it close to the wall will increase the bass; placing it across a room corner will increase the bass further, possibly at the expense of clarity. Do not place the subwoofer close to surfaces or objects that may rattle. The floor under the subwoofer should be sound. Experiment with a variety of locations and sources before making a final decision.

REAR PANEL CONNECTIONS

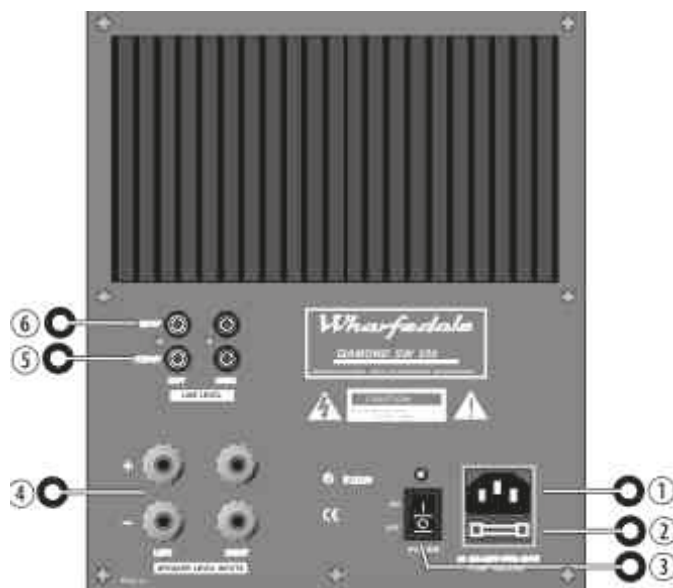

- | | |
|----------------------|-------------------------------|
| ① Mains Input | ④ Speaker (High) Level Inputs |
| ② Mains Fuse | ⑤ Line Level Outputs |
| ③ Mains Power Switch | ⑥ Line Level Inputs |

CONNECTING THE SUBWOOFER

Power Connections

Before connecting your subwoofer check that the mains voltage marked on the amplifier panel is correct for your mains supply.

- 230 volt products - 220 volts to 240 volts
- 115 volt products - 110 volts to 120 volts

Connecting to a Digital AV processor

If your AV processor has a line level or LFE subwoofer output you should use this connection. You will need to purchase a single screened RCA phono lead from your dealer. Connect this lead to the Left line input of the Subwoofer as shown below.

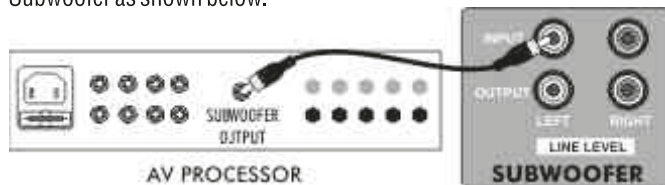

Stereo Line Level Connections

Stereo line level connections will be necessary where there is no dedicated single subwoofer output, but where there is either:

- A stereo subwoofer line output or a separate preamp output.
- In stereo systems where there is a suitable preamplifier line output, or if an integrated amplifier, a pre/main link that can be separated.

The output must be controlled by the system volume control - a tape output is not suitable. If you are in doubt, consult your dealer.

Stereo Connections: Connect a stereo RCA phono cable from the line output of the preamp to the Subwoofer line inputs.

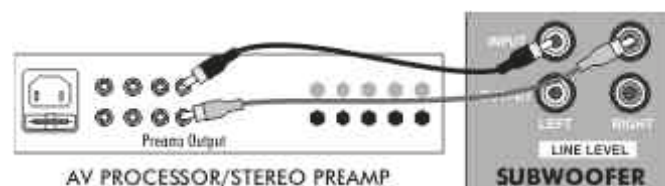

Pre Out - Main In Connections

If you use a separate stereo pre and power amplifier, or an amplifier where the pre and main amplifier can be separated, connect the subwoofer as shown. There are two alternative methods.

A: You will need two screened RCA 'Y' adaptors and two single RCA phono cables.

Remove the Pre-Main links on your amplifier. Connect the socket (common) of an RCA 'Y' adaptor to one of the mono cables. Connect one leg of the 'Y' adaptor to the Left Channel Pre Out socket on the amplifier and the other leg to the Left Channel Main In socket. Connect the remaining plug on this combination to the Left Channel Line Level Input on the subwoofer. Repeat this for the Right Channel.

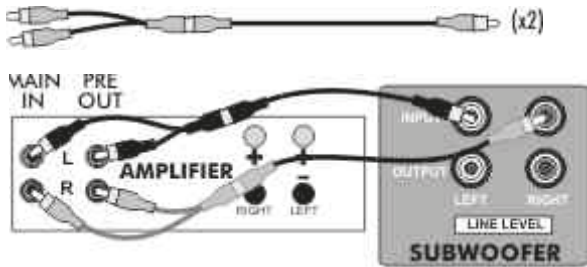

B: You will need two stereo (or four single) screened RCA cables.

Connect a Stereo cable from the Line Level Inputs of the subwoofer to the Pre Out sockets of the amplifier. Now connect a second Stereo cable from the Line Level Outputs of the sub-woofer to the Main In sockets of the amplifier. Make sure that the Right and Left Channels are not mixed up! The sub-woofer is now inserted within the system loop.

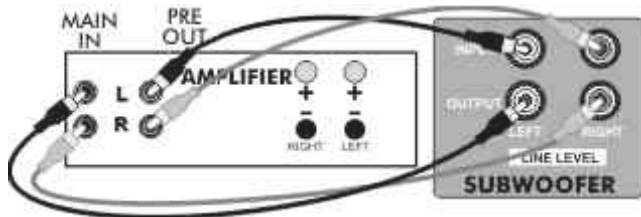

Speaker Level Connections

The high level Speaker connections should be used only if your amplifier does not have a line level subwoofer output. In this connection the subwoofer is fed together with the Front loudspeakers. For this you will need two extra twin core cables.

Choose a good quality audio speaker cable of reasonable gauge. Avoid using cheap 'bell' or 'zip' cables. Audio speaker cable has a polarity stripe or rib along one conductor to simplify connecting your speakers.

Split the cable at each end to a depth of 25mm. Strip about 7mm of insulation from each end and lightly twist to gather the wire strands.

The Speaker Level connectors are screw terminals located on the control panel. Unscrew a terminal and insert the cable into the hole at the base. Retighten the terminal securely. Make sure that the terminal grips the bare wire and there are no loose strands which could touch adjacent terminals.

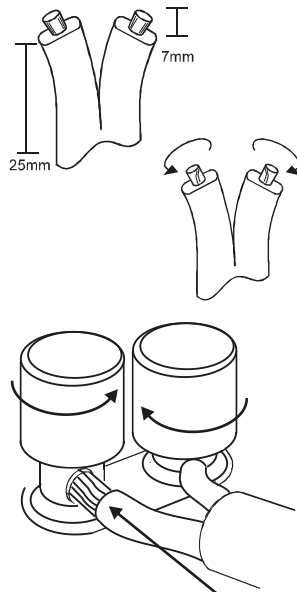

There are two methods of connecting the subwoofer:

A: Ensure the Front loudspeakers are correctly connected.

Using one of the additional twin core cables, connect the Left Speaker Terminals on the sub bass unit to the Front Left speaker terminals on the amplifier. Connect the Red (+) speaker terminal on the amplifier to the Red (+) terminal on the subwoofer. Connect the Black (-) speaker terminal on the amplifier to the Black (-) terminal on the subwoofer. Now connect the Right Speaker terminals on the subwoofer to the Front Right speaker terminals on the amplifier.

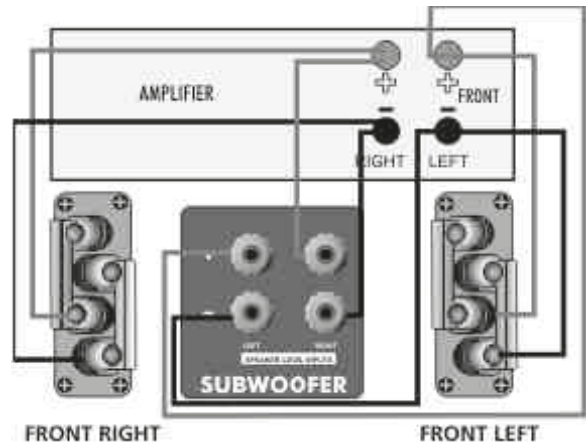

B: Alternatively you may connect the subwoofer to the Front speakers.

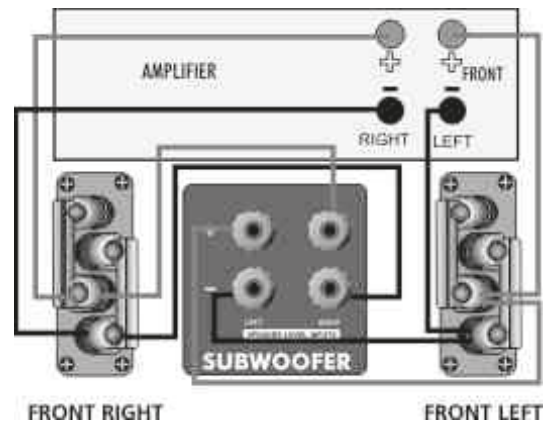

If your speakers are bi-wired: You should ensure that you connect the subwoofer to the BASS terminals ONLY.

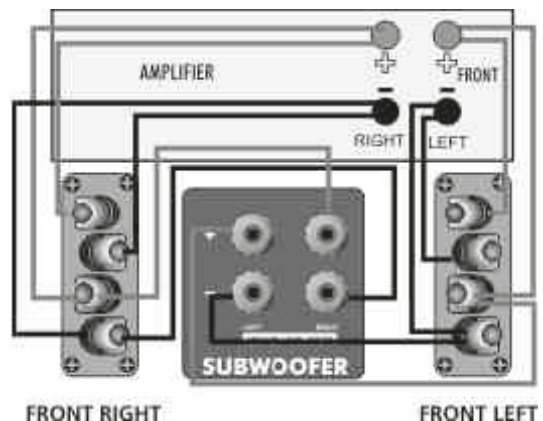

When routing any cables to loudspeakers do not run them across open floor spaces where they may cause danger to people and pets. Route them safely, around room boundaries if necessary.

OPERATING YOUR SUBWOOFER

Remote Handset

All control functions are carried out using the remote handset.

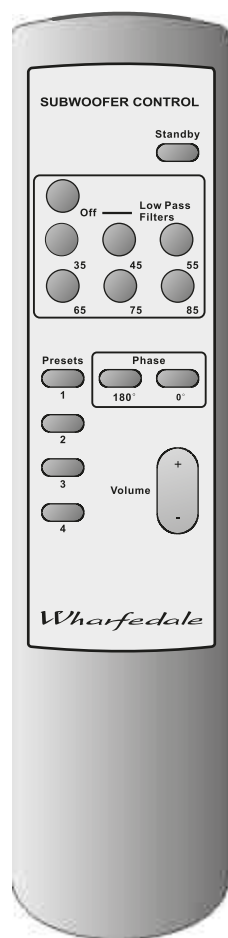

Installing batteries

The handset operates on two LR6 (AA) batteries which are supplied. The battery compartment is located at the rear of the handset. Unwrap the batteries and slide the cover off the handset. Place the batteries in the handset, the correct orientation is shown on the diagram. When the batteries are installed, replace the cover.



Switching on the Subwoofer

Check that all the connections to the subwoofer have been properly made and that the system volume control is at minimum. Plug the supplied power cord into the mains socket on the rear panel. Plug the mains plug into the wall socket and switch the power on. Now switch the subwoofer on with the rest of your system. The subwoofer on/off switch has a rocker action; press the upper part to switch the equipment on and the lower part to switch it off. When switched on the light above the power switch will glow and the subwoofer will be operational.

Operation - Controls and Functions

Control functions are carried out using the remote handset. To operate, the handset must be pointed at the subwoofer and be in direct line of sight.

Standby: The Standby key brings the subwoofer in and out of Standby.

The drawing below shows a typical front panel display during operation.



The preset light will not light if no preset has been set up or if a preset has been over-ridden.

In Standby mode all the lights on the subwoofer front panel are extinguished. The rear panel light remains on to show the unit is powered.

Volume: Press the Volume + key to increase the volume level. Press the Volume - key to decrease the volume level of the subwoofer. The volume range on the front panel display varies from 00 (minimum) to 99 (maximum).

Low Pass Filters: Pressing the appropriate filter key will select the frequency at which the subwoofer rolls off. The filter has steps at Off and 35Hz-85Hz in 10 Hz increments. When 'OFF' is selected the subwoofer operates over its full designed range. Pressing other keys lowers the maximum operating frequency. The Low Pass Filter value should be chosen having regard to the nature of the Front speakers and programme material. Follow the Setup Notes on Page 6 and the instruction manual of your AV processor (if used) for more guidance.

Phase: This key toggles the subwoofer between 0° and 180° phase shift.

Presets: Four different settings of level, frequency and phase can be stored. Pressing and holding any of the preset keys on the remote for 3 seconds will cause the current settings to be stored in that preset. The display will show the preset number then flash the preset number once to show it has stored the preset.

To change from one preset to another, press a preset key on the remote for less than 3 seconds to recall the settings of that preset. The display will show the preset number:

If you select a preset and then alter any aspect of the setup, the preset light will extinguish (as the setup no longer matches the preset).

Note: When brought out of standby for the first time, the unit will display the factory presets. Thereafter, bringing the unit out of standby will revert it to the operational state last used. If you switch the power on and off at the rear panel while the unit is in standby, the unit will power up to a normal operating state (i.e. not in standby). To enter standby, again press the Standby key.

SETTING UP YOUR SUBWOOFER

General Notes

Your subwoofer is most likely to be used with two typical programme sources, music and movies. The setup for these two very different sources may be different if best results are to be achieved. Please read these setup notes in conjunction with your processor and speaker manuals.

All setting up of the subwoofer should be performed with tone controls and filters set 'flat'.

Listening Rooms and Subwoofer Positioning:

Listening rooms are not ideal. Most rooms are reverberant with some parallel walls. Because of room geometry and construction there will be areas with severe peaks at some frequencies and severe troughs at others. These peaks and troughs are called 'standing waves' and if you site loudspeakers in such areas the response will be highly non-linear. With subwoofers this situation is exacerbated by the fact that it is easier to treat high frequency irregularities by the use of drapes, soft furnishings etc., but very hard to do the same at bass frequencies due to the very long wavelengths - at 40 Hz the wavelength is almost 9 metres!

To help locate standing waves in your listening room, one idea is to sit in the listening seat and recruit a friend with a deep voice to speak as he moves around the area where you propose to site your subwoofer - you will soon find out where not to site it! Where the voice sounds most natural is a good place to start.

The low frequency response of the subwoofer and its blend with the main loudspeakers is greatly affected by positioning. Although bass is enhanced by walls or corners, so often is coloration. As the drive unit faces downward, the floor will influence the sound. The surface under the subwoofer should be stable and unobstructed. If the carpet is thick, consider placing the subwoofer on a solid surface such as a marble slab.

The subwoofer has to blend with the main speakers: if you place the subwoofer where it amplifies the irregularities of the room or the main speakers the result will be bloated, coloured bass. If acoustic guitar and male voice sounds coloured when the subwoofer is operating and less coloured when in standby, you need to address the positioning first before adjusting any controls

Loudspeaker Phasing

Make sure that all loudspeaker channels are connected in phase. Nothing is more certain to defeat a Home Cinema or Stereo setup involving a subwoofer than one(or more) channels being out of phase. In Stereo, if there is a doubt about the way the loudspeakers are connected, check their phasing by playing a mono source - the sound should appear from a point midway between the two loudspeakers. If this position is indefinite, reverse the connections to one of the loudspeakers. Correctly connected loudspeakers give a definite centre sound source with fuller bodied tenor and bass registers.

Setting the Phase of the Subwoofer

Phase at very low frequencies is not straightforward to detect. Initially we suggest you temporarily set the low pass filter to 'off' and the phase to 0° and play some bass heavy music in Stereo through the main speakers and the subwoofer. From the listening position, switch the phase between 0° and 180°. The setting which appears to give the greater bass output is correct. Now follow the instructions below for setting the low pass filter.

Home Cinema Systems

Low Pass Filter

If you are using a digital AV processor the initial setting should be 'OFF' as the processor will have its own bass management system. Most digital AV Processors ask you to specify the size of speakers in the various channels. These are usually 'Large' or 'Small'. This sets the bass management for the system. Unless your loudspeakers are large floor standing units, you should choose 'Small' for the Front channels, as the subwoofer is going to be better at providing clean, deep bass. Choose 'Small' for the surround channels and also for the Centre channel, so that any bass from these channels will be directed to the subwoofer. Set the 'Subwoofer' option on the processor to **'On' or 'Yes'**.

After experimenting with various sources you may need to adjust the LPF settings. The goal is to ensure the subwoofer blends seamlessly into the sound stage. Setting the subwoofer to Standby should reduce the bass extension, not change the bass level - as always personal taste plays an important part.

Setting levels

Once the loudspeaker settings have been finalised, put the AV amplifier into its "Test" mode (see instructions supplied with your processor.) Adjust the levels until all channels are reproduced at equal loudness. When adjusting the subwoofer output level avoid setting too high a level or you will swamp the sound with bass which be tiring to listen to and may limit the subwoofer's ability to respond to large bass transients. Set a sensible level going into the subwoofer from the processor. The volume display should be around 50 at normal listening levels.

LFE

This channel was originally an additional bass channel with its own dedicated subwoofer. In practice however, if any speakers are set to 'Small', the LFE channel is combined with the bass from those channels and fed into the subwoofer. When you set the LFE level from your AV processor, use care as the LFE channel contains powerful low frequencies which, although normal in a cinema, may overload a domestic subwoofer. If, during a programme, you hear popping or thumping noises from the subwoofer, turn the AV Processor volume level down and back off the LFE level. If this does not cure the problem, lower the subwoofer volume level.

Note: If any channels are set to 'Small' the subwoofer must be on when the system is playing otherwise there will be reduced bass, as well as no LFE.

Stereo Reproduction

Low Pass Filter: The low pass filter should be set having regard to the size and low frequency extension of the main speakers. The role of the subwoofer is to extend the bass response of the system not to increase the overall bass level. If the loudspeakers are large the LPF should be set low, a value around 45-55 Hz is a good place to start. With smaller speakers this can be increased, up to 85Hz for very small bookshelf units. As always the final value is determined by listening.

Low-level Listening

Our ears are far more sensitive to midrange frequencies (2-5 kHz) than bass frequencies. Very low bass and especially percussive bass is 'felt' rather than heard. At low sound levels bass frequencies appear to attenuate faster than midrange and treble. As the level increases this bass roll-off decreases and at loud volumes is negligible. The pioneering work was done in the 1930's by Fletcher and Munson who produced a series of 'Equal Loudness Contours'. Occasionally we may wish to listen to a normally loud piece of music at a low level but with retention of the bass information. There may be a case for assigning a preset for low level listening where the subwoofer volume is set somewhat higher and the LPF is set a little lower - as always this is for individual judgement.

Testing the system By Ear

The simplest way to test the system is to play, at a moderate level, music with deep consistent bass. Switching the subwoofer in and out of Standby should cause change of the depth of bass, and the ambience will also alter. If there is a significant change in bass volume, or a noticeable step in the bass response, or an increase in coloration when the subwoofer is playing, the setup needs to be refined further. By entering different settings in different presets, you will be able readily to identify the most favourable combination.

Using an SPL Meter

This is done with a test disc or signal generator and is beyond the scope of this handbook except to observe that SPL meter settings are weighted 'A', 'B' and 'C' - these correspond to the inverse of the Fletcher-Munson Equal Loudness Contours at 40, 70 and 100dB. For normal listening levels the SPL meter is usually set to 'C' and the response set to slow. If you wish to use this setup method you should definitely seek your dealer's advice beforehand.

SETTING UP TWO SUBWOOFERS

General notes

Site the subwoofers so that they enhance the system bass response but do not cancel each other out.

- A well-sited pair of subwoofers for stereo applications will be adequately sited for Home Cinema applications.
- A second subwoofer raises the bass output level 6dB when operating in Home Cinema but not in Stereo.
- Both subwoofers should be in line of sight to the listening seat as both answer to one remote handset.
- When operating two subwoofers, do all setups and operations on one handset. When allocating presets make sure that the same preset (e.g. Home Cinema on preset 1) is allocated to each subwoofer.

Home Cinema:

- As AV Processors produce a common subwoofer channel, considerations of Left and Right do not apply, but with spaced subwoofers each helps to fill in the troughs caused by in-room standing waves, smoothing the bass and giving the sound greater intensity, 'air' and depth.
- Set up the position of each subwoofer separately with the other one switched off. After you have set both subwoofers up, reduce the front panel volume level of each subwoofer by 3 points. Complete the final adjustment with both subwoofers switched on. You may need to make some small adjustments to the position of each sub for best results. We suggest you enter this final setting as a Home Cinema preset.

Stereo:

- Each subwoofer should be located as near as possible to its partnering loudspeaker. The smaller the main speakers, the more necessary this becomes.
- It is easier to set up each subwoofer with a mono source playing through one channel with the other channel turned off.
- Complete the adjustment by ear using a mono source with both channels and subwoofers operational. We suggest you enter this setting as a Stereo preset.

HOME CINEMA LINE CONNECTION

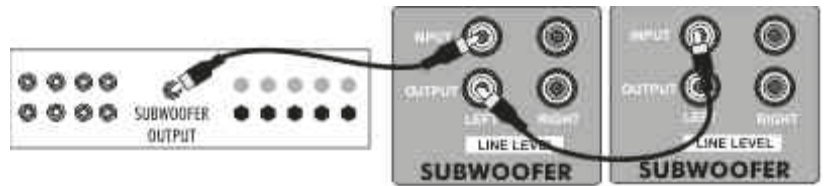

STEREO LINE CONNECTION A

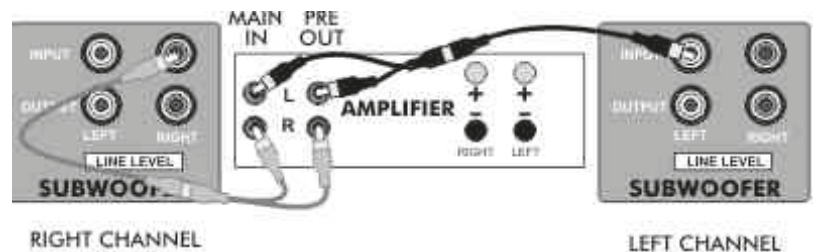

STEREO LINE CONNECTION B

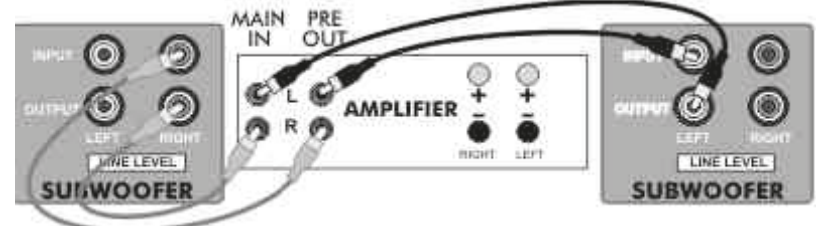

HIGH LEVEL SPEAKER CONNECTION

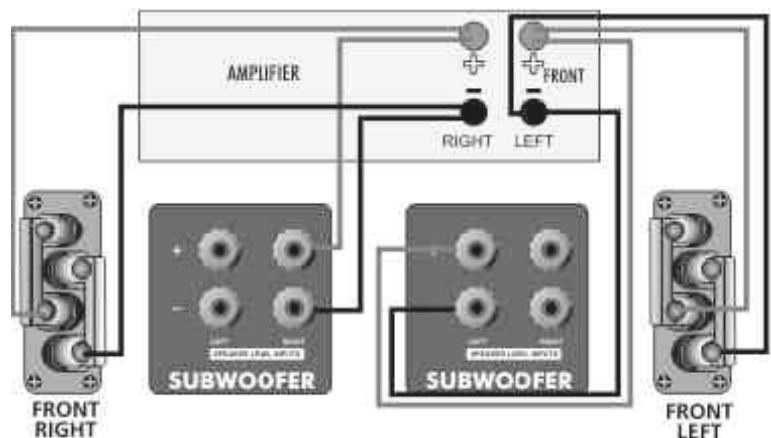

SUBWOOFER SPECIFICATIONS

| Model | SW 150 | SW 250 |
|--|---------------------------------|---------------------------------|
| Format | Powered Subwoofer | Powered Subwoofer |
| Drive Unit | 250 mm long throw | 250 mm long throw |
| Amplifier Power | 150W | 250W |
| Line Input Sensitivity | 200mV for 75W | 325mV for 150W |
| Averaged Max. O/P (@ 1M) | 110 dB | 113 dB |
| Frequency Response (Boundary Position) | 35 Hz – 110 Hz | 30 Hz – 100 Hz |
| Low Pass Filter Frequencies | 35 Hz – 85 Hz (6x10Hz steps) | 35 Hz – 85 Hz (6x10Hz steps) |
| Phase Adjustment | Switchable 0° - 180° | Switchable 0° - 180° |
| Dimensions (H x W x D) mm | 330 x 330 x 370 | 420 x 420 x 375 |
| Height on Feet mm | 360 | 478 |

DIAMOND 9 LOUDSPEAKER SPECIFICATIONS

BOOKSHELF MONITORS

| Model | 9.0 | 9.1 | 9.2 | 9.3 |
|-----------------------------|-----------------|-----------------|-----------------|-----------------|
| Format | Stand/Shelf | Stand/Shelf | Stand/Shelf | Stand/Shelf |
| Bass | 100 mm | 130 mm | 165 mm | 200 mm |
| Tweeter | 25mm Dome | 25mm Dome | 25mm Dome | 25mm Dome |
| Power Handling (Programme) | 15 - 75 W | 20 - 100 W | 20 - 100 W | 30 - 120 W |
| Impedance | 6 Ohms | 6 Ohms | 6 Ohms | 6 Ohms |
| A/V Shielded | Yes | Yes | Yes | Yes |
| Sensitivity (2.83V, 1M) | 86 dB | 86 | 86 | 88 |
| Freq Range | 60 - 24KHz | 50 - 24KHz | 45 - 24KHz | 40 - 24KHz |
| HF limit (-10dB) | 44Khz | 44Khz | 44Khz | 44Khz |
| Crossover Frequency | 2.2 KHz | 2.3 KHz | 2.0 KHz | 2.0 KHz |
| Frequency (Fb) | 55 Hz | 50 Hz | 45 Hz | 40 Hz |
| Dimensions (H x W x D) mm | 236 x 145 x 165 | 296 x 194 x 278 | 364 x 223 x 301 | 450 x 247 x 331 |

FLOORSTANDING LOUDSPEAKERS

| Model | 9.4 | 9.5 | 9.6 |
|-----------------------------|-----------------|-----------------|-----------------------|
| Format | Floorstanding | Floorstanding | Floorstanding |
| Bass | 165 mm | 165 mm | 2 x 200 mm |
| Midrange | | 165 mm | 50mm Dome |
| Tweeter | 25mm Dome | 25mm Dome | 25mm Dome |
| Power Handling (Programme) | 20 - 100 w | 30 - 150w | 40 - 200 w |
| Impedance | 6 Ohms | 6 Ohms | 6 Ohms |
| A/V Shielded | Yes | Yes | Yes |
| Sensitivity (2.83V, 1M) | 86 dB | 88 dB | 90 dB |
| Freq Range | 40 - 24 KHz | 30 - 24 KHz | 28 - 24 KHz |
| HF limit (-10dB) | 44 KHz | 44 KHz | 44 KHz |
| Crossover Frequency | 2.0 KHz | 140Hz:2.2 KHz | 150Hz:1.0 KHz:6.0 KHz |
| Frequency (Fb) | 40 Hz | 35 Hz | 30 Hz |
| Dimensions (H x W x D) mm | 800 x 223 x 301 | 900 x 223 x 301 | 1080 x 247 x 331 |
| Height on Spikes mm | 850 | 950 | 1133 |

IMPORTANT NOTE

All Diamond 9 loudspeakers are rated at 6 Ohms but are compatible with all standard amplifier outputs-even those which state an 8 ohm minimum impedance.

AUDIO VISUAL LOUDSPEAKERS

| Model | 9.CC | 9.CS | 9.CM | 9.SR | 9.DFS |
|-----------------------------|-----------------|-----------------|-----------------|-----------------|-----------------|
| Format | Centre Channel | Centre Channel | Centre Channel | Surround | Surround |
| Bass | 2 x 100 mm | 2 x 130 mm | 2 x 165 mm | 100 mm | 2 x 100 mm |
| Mid | | | 50 mm Dome | | |
| Tweeter | 25mm Dome | 25mm Dome | 25mm Dome | 25mm Dome | 25mm Dome |
| Power Handling (Programme) | 15 - 120 W | 20 - 120 W | 30 - 150 W | 10 - 60 W | 15 - 200 W |
| Impedance | 6 Ohms | 6 Ohms | 6 Ohms | 6 Ohms | 6 Ohms |
| A/V Shielded | Yes | Yes | Yes | No | No |
| Sensitivity (2.83V, 1M) | 88 dB | 89 dB | 90 dB | 88 dB | 86 dB |
| Freq Range | 80 - 24KHz | 70 - 24KHz | 70 - 24KHz | 70 - 24KHz | 70 - 24KHz |
| HF limit (-10dB) | 44KHz | 44KHz | 44KHz | 44KHz | 44KHz |
| Crossover Frequency | 2.8 KHz | 2.8 KHz | 1.0 KHz, 6KHz | 2.2 KHz | 3.5 KHz |
| Frequency (Fb) | 70 Hz | 65 Hz | 75 Hz | 70 Hz | 80 Hz |
| Dimensions (H x W x D) mm | 120 x 330 x 130 | 189 x 400 x 233 | 223 x 515 x 265 | 236 x 185 x 117 | 280 x 290 x 132 |
| Height on Feet mm | 128 | 199 | 233 | | |

TROUBLESHOOTING

If your system is not working properly please work through this checklist before returning a unit to your dealer. Before investigating a problem, always switch off the system at the mains.

| Symptom | Possible Cause |
|---|---|
| No Sound | System not switched on; Speaker cables shorting terminals out; Wrong source selected |
| Sound lacks bass content Bass reproduction indistinct | Front loudspeakers out of phase. Subwoofer not switched on; Subwoofer phase incorrect; Subwoofer crossover control too low |
| Excessive bass distortion at low volumes | Subwoofer level set too high; LFE level set too high; Subwoofer incorrectly wired |
| Excessive or distorted bass at high levels | System level set too high; Bass control set too high; Speakers too close to room corners |
| Distorted or rattling sounds at high levels | System level too high; Objects on speakers/subwoofer; Objects too close to subwoofer |
| SW 250 will not respond to commands | Handset batteries weak; handset too far away; line of sight is impeded |
| Popping or thumping from the subwoofer | System level set high; Subwoofer level set too high; LFE level set too high |
| Indistinct sound; Poor localisation of effects. Poor localisation of dialogue | One or more loudspeakers is out of phase (Read the manual for correct connection procedure) |
| Television picture colour is distorted | Subwoofer too close to TV. (Switch off system and TV. Move units away. Leave 15 mins. Switch on) |

CARE AND MAINTENANCE

If you play the speakers with the grilles off exercise great care. NEVER touch the drive units which are easily damaged.

The loudspeaker cabinets can be cleaned with a damp cloth or with a spray furniture polish and a soft cloth. Apply the spray sparingly to the cloth and then polish the cabinet. Never apply spray directly to the cabinet.

GUARANTEE & SERVICE

In the unlikely even that your unit develops a fault you should return it to your Wharfedale dealer using the original packing to ensure safe shipping.

The terms of your guarantee may vary in different countries but in all cases the guarantee excludes:

All damage caused through accident, misuse, wear and tear, neglect, incorrect installation, adjustment or repair by unauthorised personnel.

Liability for damage or loss occurring in transit to or from the purchaser.

Wharfedale will not be liable for any consequential damage, loss or injury, arising from or in conjunction with this equipment.

AUTHORISED SERVICE CENTRES

UK

Wharfedale International Ltd.
IAG House, Sovereign Court,
Ermine Business Park,
Huntingdon,
Cambs PE29 6XU,
England.
Tel: +44 (0)1480 447700
Fax: +44 (0)1480 43176

USA

IAG America, Inc.
15 Walpole Park
South
Walpole
MA 02081

CANADA

Korbon Trading Ltd
6800 Kitimat Road
Units 19-20
Mississauga
Ontario
Tel: +1 905 567 1920

For information on other authorised service centres worldwide contact Wharfedale International in the U.K.

A worldwide distributor list is available on the Wharfedale website:

www.wharfedale.co.uk

The name 'WHARFEDALE' is a registered trademark of Wharfedale International Ltd.

Wharfedale has a policy of continuous product development and reserves the right to change specification without notice.

Wharfedale is a member of the International Audio Group.

COMPLIANCE

This Wharfedale product complies with the relevant clauses enshrined in the following standards and directives in force at the time of the introduction of the product.

- **EU Directives:** 89/336/EC, 72/23/EEC: **Safety:** EN60065 (CB Scheme): **Emissions:** EN55013, EN61000 **Immunity:** EN55020:2002.
- **USA:** UL 6500:2002. Approved under the verification provision of FCC Part 15 as a Class B Digital Device.
- **CANADA:** CAN/CSA-E60065-00



Wharfedale