

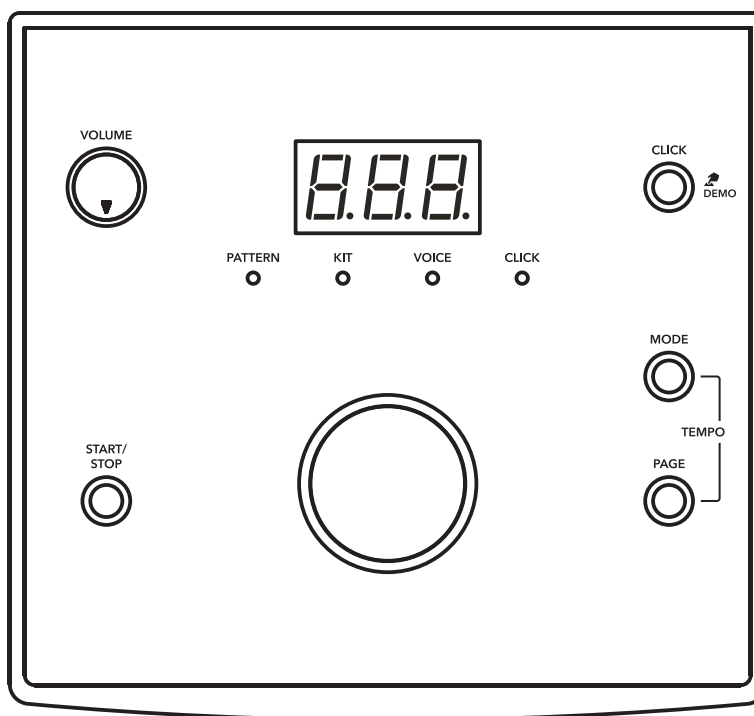

DD420X



USER MANUAL



INFORMATION FOR YOUR SAFETY!

CAUTION

The normal function of the product may be disturbed by Strong Electro Magnetic Interference. If so, simply reset the product to resume normal operation by following the owner's manual. In case the function could not resume, please use the product in other location.

CAUTION

Changes or modifications not expressly approved by the party responsible for compliance could void the user's authority to operate the equipment.

PRECAUTIONS

PLEASE READ CAREFULLY BEFORE PROCEEDING

Please keep this manual in a safe place for future reference.

Power Supply

Please connect the designated AC adaptor to an AC outlet of the correct voltage.

Do not connect it to an AC outlet of voltage other than that for which your instrument is intended.

Unplug the AC power adaptor when not using the instrument, or during electrical storms.

Connections

Before connecting the instrument to other devices, turn off the power to all units. This will help prevent malfunction and / or damage to other devices.

Location

Do not expose the instrument to the following conditions to avoid deformation, discoloration, or more serious damage:

- Direct sunlight
- Extreme temperature or humidity
- Excessive dusty or dirty location
- Strong vibrations or shocks
- Close to magnetic fields

Interference with other electrical devices

Radios and televisions placed nearby may experience reception interference. Operate this unit at a suitable distance from radios and televisions.

Cleaning

Clean only with a soft, dry cloth.
Do not use paint thinners, solvents, cleaning fluids, or chemical-impregnated wiping cloths.

Handling

Do not apply excessive force to the switches or controls.

Do not let paper, metallic, or other objects into the instrument. If this happens, unplug the AC adaptor from the wall outlet. Then have the instrument inspected by qualified service personnel.

Disconnect all cables before moving the instrument.

Contents

Panel Description

Front Panel	4
Rear Panel	4

Setup

Connect the Pads and the Pedal	5
--------------------------------------	---

Connections

Connect an Audio Equipment	6
Connect a CD Player, Etc.(Aux in Jack)	6
Connect Headphones	6
Connect the Power Supply Jack	6
MIDI and USB	6

MENU

Menu	7
------------	---

Operation

Switch the Power ON	7
Automatic Power Off Instruction.....	7
Set the Main Volume	7

Pattern

Select a Pattern	8
Adjust the Accompaniment Volume	8
Adjust the Drum Volume	8

Drum Kit

Select a Kit	9
Adjust the Kit Volume	9

Switch Reverb On/Off	9
----------------------------	---

Voice

Select the Voice	10
Adjust the Voice Volume	10
Adjust the Midi Note	11

Tempo

Adjust the Tempo	11
------------------------	----

Click

Adjust the Click Time Signature	12
Adjust the Click Interval	12
Adjust the Click Instrument	12
Adjust the Click Volume	12

Restore the Factory Preset	13
---	-----------

Play the Demo	13
----------------------------	-----------

Play the Pattern	13
-------------------------------	-----------

Play the Click	13
-----------------------------	-----------

Appendices

Specifications	14
Preset Drum Kit List	15
Drum Instrument List	15
Preset Pattern List	15
GM Backing Instrument List	16
GM Drum Kit List	17
MIDI Implementation Chart	19

Panel Description

Front Panel

1 MASTER VOLUME KNOB

Control the volume of phone and line out. Turn it clockwise to increase the volume and anticlockwise to decrease the volume.

2 [START/STOP] BUTTON

Start or stop Pattern playing.

3 LED DISPLAY

3-digit LED and LED indicators

4 DATA DIAL

Turn this knob to select drum kits or quickly edit the current value shows on the 3-digit LED (increase/decrease value, select specified item).

5 [MODE] BUTTON

Press [MODE] button to select the mode from PATTERN, KIT, VOICE, CLICK.

6 [PAGE] BUTTON

Press [PAGE] button to browse the menu pages of current selected mode.

Press both [MODE] and [PAGE] buttons, the 3-digit LED will display the tempo page, it will temporarily display for 3 seconds, then turn the DATA DIAL knob to adjust the tempo.

7 [CLICK] BUTTON

Press [CLICK] button to start/stop the click. Hold on the [CLICK] button 2 seconds to play the demo.

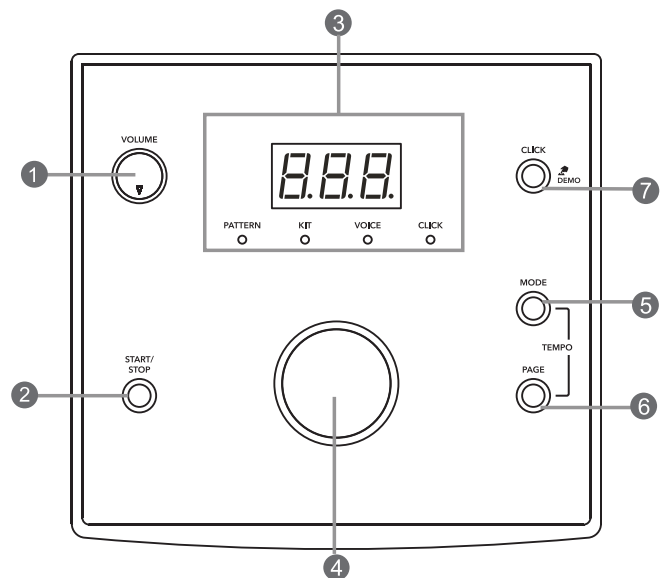

Rear Panel

8 POWER SUPPLY JACK (DC IN 9V)

Connect an AC adaptor to this jack.

9 POWER SWITCH

Turn the power on/off.

10 USB PORT

Connect to computer.

11 MIDI OUT JACK

Connect with external sound module.

12 LINE OUTPUT JACKS (L/MONO & R)

Made up of right channel output and left channel output which is also used as mono line output.

13 AUX IN

Connect with external sound source.

14 PHONES JACK

Connect a pair of stereo headphones to this jack. (Connect the headphones will not mute the output jack.)

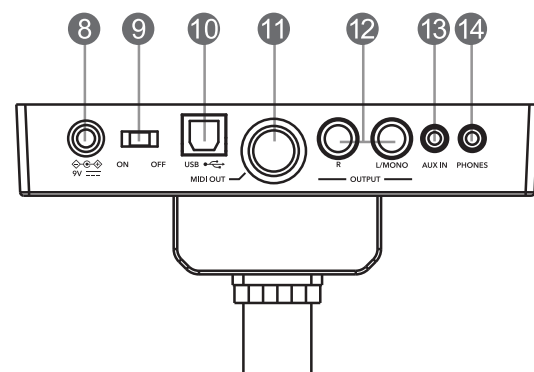

Caution!

To prevent electric shock and damage to the device, make sure the power is switched OFF on the drum and all related device before making any connection.

Connecting Pads and Pedals

Using the provided cables, the cable received by marking the corresponding drum pads, cymbal pads and pedals. (See the below illustration for reference)

Note:

1. The voice of hi-hat pad hitting is controlled by hi-hat pedal. Similar to a real drum kit, the hi-hat pad functions as an 'open hi-hat' when the pedal is released. When the pedal is stepped, it functions as a 'closed hi-hat'.
2. The valid striking area of cymbal pad (ride, crash or hi-hat) is near the edge of the pad, which is different from other pads.

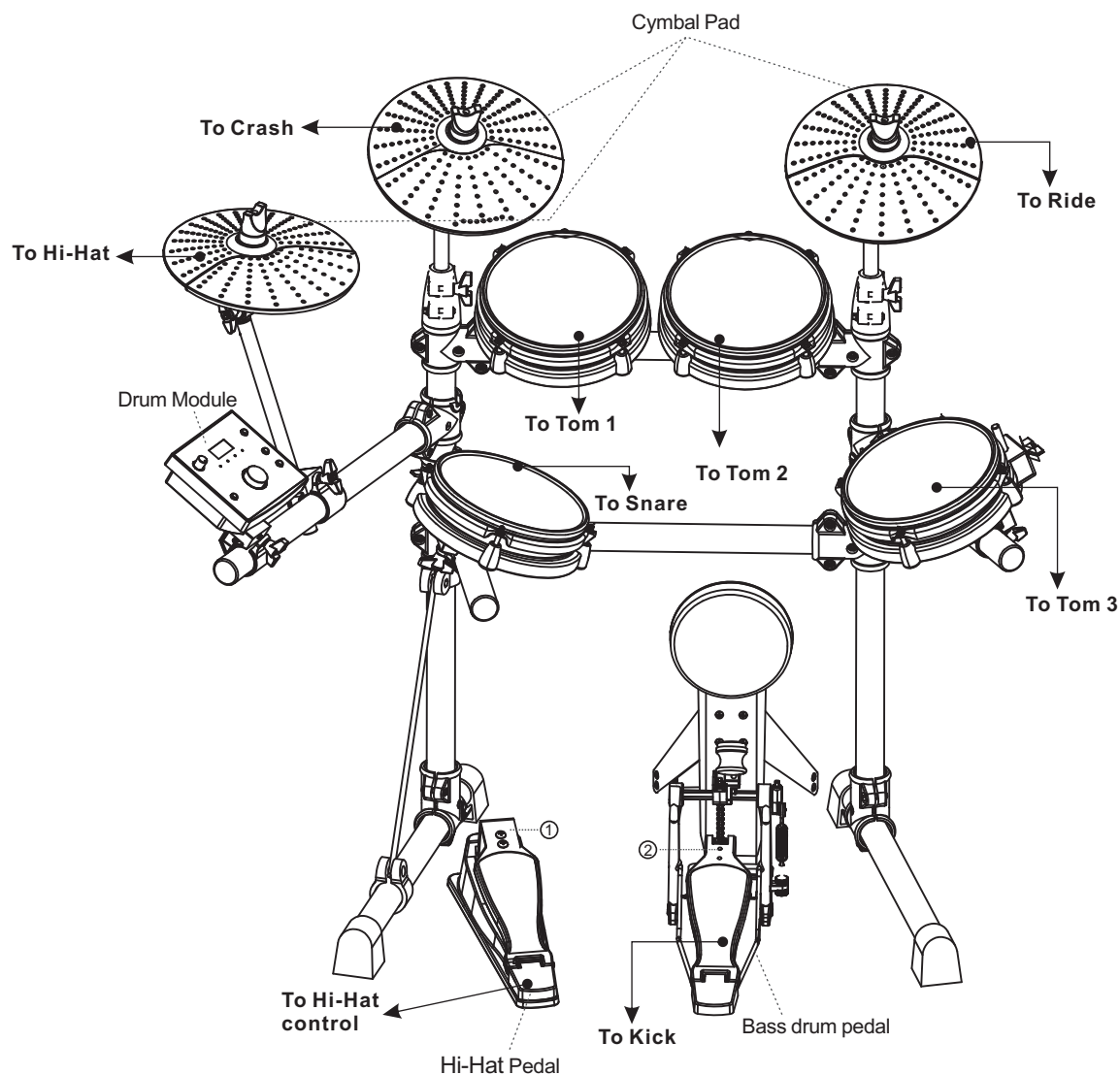

Connections

Connect an audio equipment

1. When you want to listen to the voices with an amplifier, connect amplifiers with the Output L/MONO and R jacks on the rear panel. (For monaural playback, use the L/MONO jack; for stereo playback, connect both L/MONO and R jacks.)
2. The volume is adjusted with the VOLUME knob.

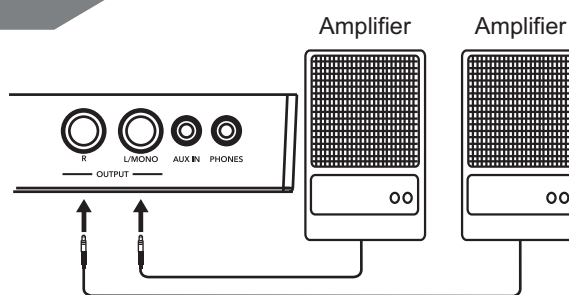

Connect a CD player, etc. (Aux. In jack)

1. The audio output of a CD player, or other audio source, to connect with the AUX IN jack on the rear panel can be mixed with the sound of the drum. This function is convenient that let you play along with a favourite song.
2. The volume of the external signal is adjusted with the VOLUME knob.

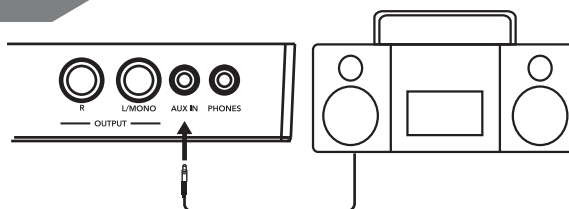

Connect headphones

An optional set of stereo headphones can be connected with the PHONES jack located on the rear panel of the drum module.

- * Adjust the volume to a comfortable level.

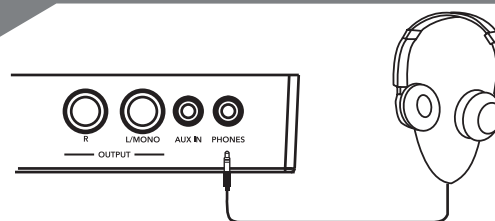

Connect the power supply jack

Make sure the power is switched OFF and connect the power adaptor with the DC IN jack on the rear panel.

Note:

1. To protect the speakers, amplifier and the drum module from damage, rotate the volume knob to the minimum volume level before switching the power ON.
2. Make sure the power is switched OFF when connecting drum module with external devices.

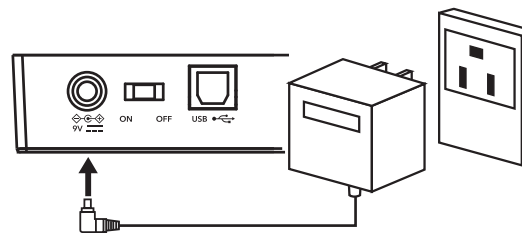

MIDI and USB

MIDI stands for Musical Instrument Digital Interface, this is a world-wide standard communication interface that enables electronic musical instruments and computers (of all brands) to communicate with each other so that MIDI command and other data can pass between them. This exchange of information makes it possible to create a system of MIDI instruments and devices that offer far greater versatility and control than is available with isolated instruments. Whether you interface with computers, sequencers, expanders or other controllers, your musical horizons will be greatly enhanced.

MIDI connection

MIDI OUT: This terminal transmits data from this instrument to other MIDI devices.

USB connection

The USB connector allows you to connect the module directly to your computer. It can be connected without driver installation under the Windows & macOS environment.

The module will be recognized as 'USB Audio device' to receive and transmit MIDI messages through a single USB cable, USB is used only for MIDI messages (MIDI via USB).

Note: When the USB is connected to a computer, all MIDI messages will be received and transmitted via USB.



Menu tree

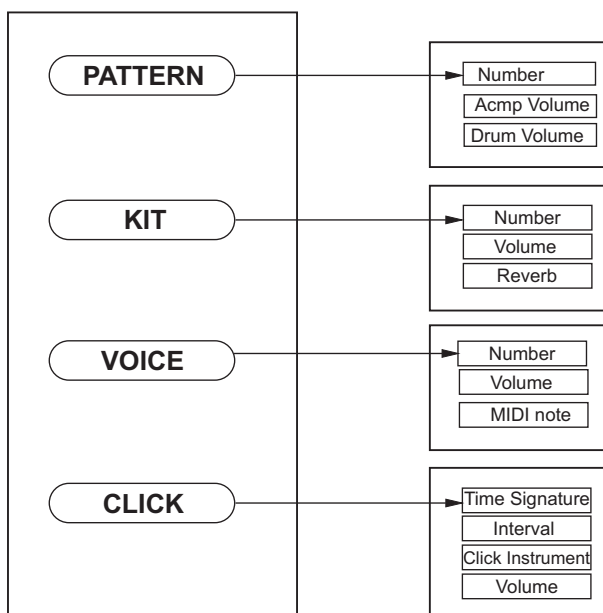

In the main menu there are 4 menu items

- PATTERN
- DRUM KIT
- VOICE
- CLICK

Operation

Press [MODE] button to change the mode.

Press [PAGE] button to select the page of current mode.

Turn the DATA DIAL to adjust the parameters.

Switch the power ON

After confirming all connection have been completed, turn the volume knob to (minimum) before switching the power on.

Set the power switch to "ON" position to switch on the power.

Display shows the kit's number and its indicator lights up.

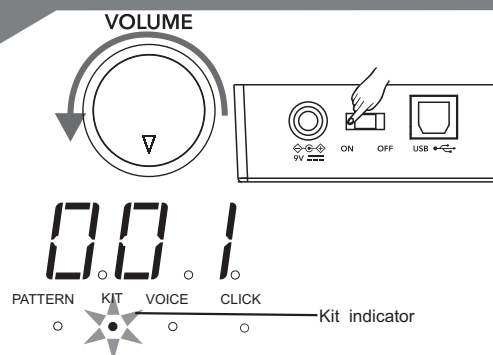

Automatic power off instruction

The drum will be powered off automatically when being idle for more than 30 (default) minutes.

If you don't need this function, just press and hold the [START/STOP] button then turn the drum on.

This function will be resumed to factory default by restarting the instrument.



Set the main volume

While hitting a pad, gradually turn the volume up to a comfortable level.



Pattern

In pattern mode, there are 3 pages:

1. Pattern number (1- 40, default 1)
2. Pattern accompaniment volume(0-32)
3. Pattern drum volume(0-32)

Select a pattern

In pattern mode, Pattern number (001-040, default 001)

1. Press the [MODE] button to select the pattern mode, the pattern LED indicator will be lighted up, the 3-digit-LED will display the pattern number(001)
2. Turn the DATA DIAL to adjust the value.
Range :(001 to 040)

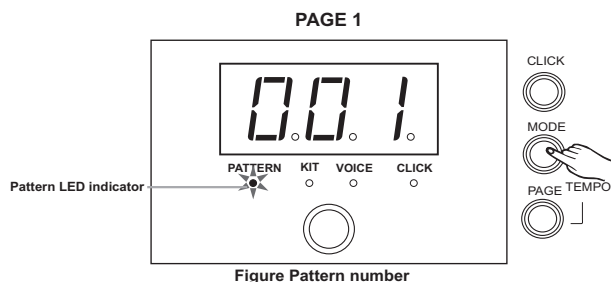

Adjust the accompaniment volume

In pattern mode, pattern accompaniment volume(A00-A32)

1. Press [MODE] button to select the pattern mode, the pattern LED indicator will be lighted up.
2. Press [PAGE] button to select the accompaniment volume page, the 3-digit-LED will display the accompaniment volume(A18).
3. Turn the DATA DIAL to adjust the value.
Range:(0 to 32).

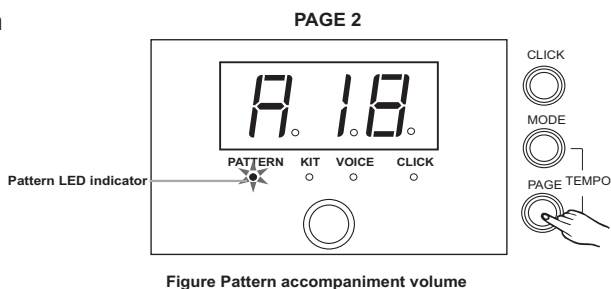

Adjust the drum volume

In pattern mode, pattern drum volume(d00-d32)

1. Press [MODE] button to select the pattern mode, the pattern LED indicator will be lighted up,
2. Press [PAGE] button to select the drum volume page, the 3-digit-LED will display the drum volume(d22).
3. Turn the DATA DIAL to adjust the value.
Range:(0 to 32)

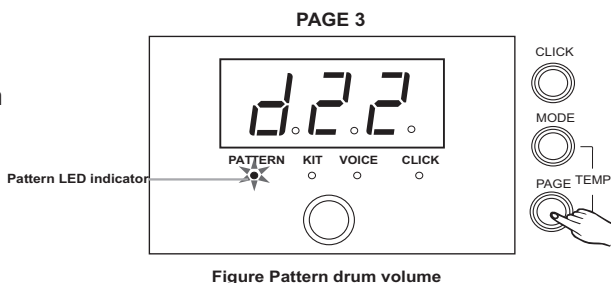

Drum Kit

- In kit mode, there are 3 pages:
1. kit number(001-010,default 1).
 2. kit volume (0-32).
 3. kit reverb:(on/off, default on).

Select a kit

In kit mode, kit number(001-010,default 1).

1. Press [MODE] button to select the kit mode, the kit LED indicator will be lighted up, the 3-digit-LED will display the kit number(001).
2. Turn the DATA DIAL to adjust the value. Range:(001-010).

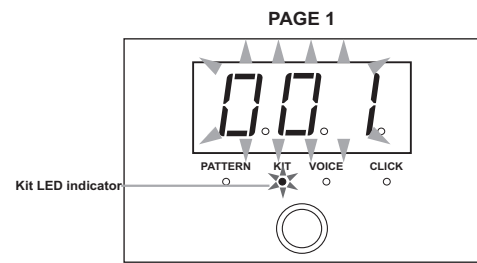

Figure Kit number

Adjust the kit volume

In kit mode, kit volume (0-32).

1. Press the [MODE] button to select the kit mode, the kit LED indicator will be lighted.
2. Press the [PAGE] button to select the kit volume page, the 3-digit-LED will display the kit volume(L30).
3. Turn the DATA DIAL to adjust the value (Automatic save). Range:(0 to 32).

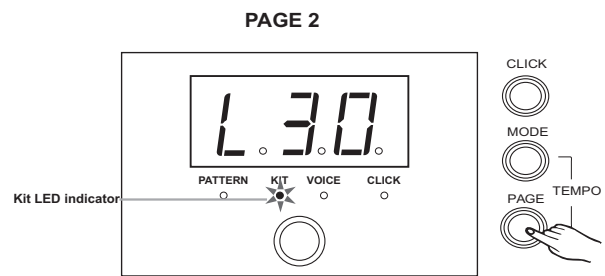
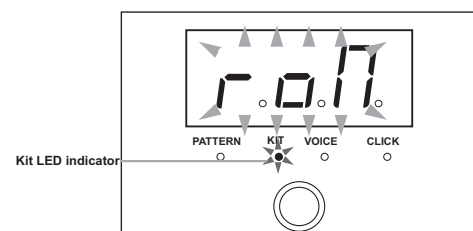

Figure Kit volume

Switch reverb on/off

1. Press [MODE] button to select the kit mode, the kit LED indicator will be lighted up.
2. Press the [PAGE] button to select the kit reverb page, reverb effect can be turn on or off by the DATA DIAL.



PAGE 3

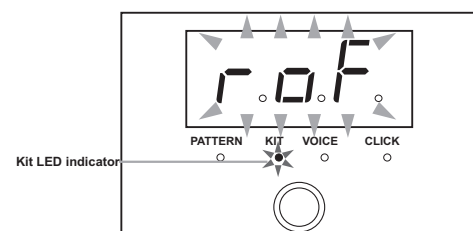

Voice

In voice mode, there are 3pages:

1. Voice number:(1-108).
2. Voice volume:(0-32).
3. Midi note:(0-99).

Select the voice

In voice mode, voice number:(1-108).

1. Press [MODE] button to select the voice mode, the voice LED indicator will be lighted up, strike a drum pad, the 3-digit-LED will display the voice number.
2. Turn the DATA DIAL to adjust the value(Automatic save). Range:(001 to 108).

NOTE:

When you select a voice for hi-hat drum, you only can select the hi-hat group voices, from group 1-group 4(Automatic save), the display is:(H-l).

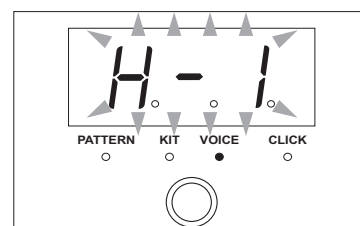
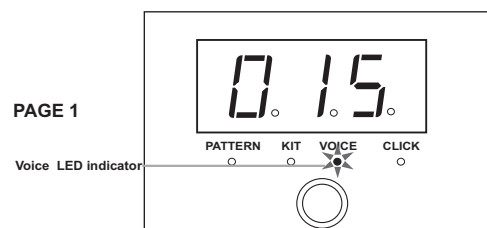

Adjust the voice volume

In voice mode, voice volume:(0-32).

1. Press [MODE] button to select the voice mode, the voice LED indicator will be lighted up.
2. Press [PAGE] button to select the voice volume page, strike a drum pad, the 3-digit-LED will display the voice volume(L30).
3. Turn the DATA DIAL to adjust the value(Automatic save). Range:(0 to 32).

PAGE 2

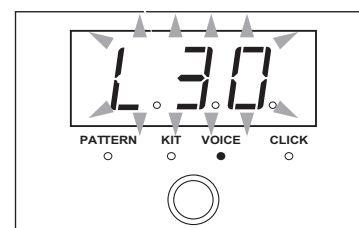

Adjust the midi note

In voice mode, midi note:(0-99).

1. Press [MODE] button to select the voice mode, the voice LED indicator will be lighted up.
2. Press [PAGE] button to select the midi note page,strike a drum pad, the 3-digit-LED will display the midi note (n48).
3. Turn the DATA DIAL to adjust the value(Automatic save). Range:(0 to 99).



THE DEFAULT MIDI NOTE:

NO.	NAME	NOTE
1	CRASH1	49
2	TOM 1	48
3	TOM 2	45
4	TOM 3	43
5	RIDE	51
6	KICK	36
7	SNARE	38
8	HIHAT CLOSE	42
9	HIHAT OPEN	46
10	HIHAT PEDAL	44

Tempo

The tempo range is 30-280

Adjust the tempo

1. Press both [MODE] and [PAGE] buttons, the 3-digit-LED will display the tempo page, it will temporarily display for 3 seconds.
2. Turn the DATA DIAL to adjust the value.

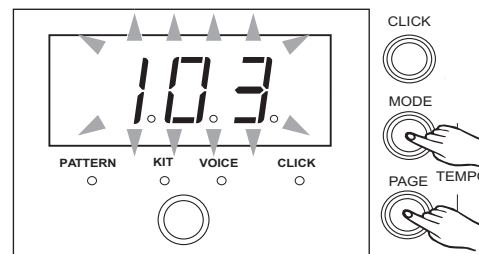

Click

In click mode, there are 4 pages:

1. Time signature:(1/4-7/4,3/8,6/8).
2. Interval:(1/4,1/8,1/12,1/16,1/24,default 1/4).
3. Instrument:(1-5,default 1).
4. Click volume:(0-32).

Adjust the click time signature

In click mode, Time signature:(1/4-7/4,3/8,6/8).

1. Press [MODE] button select the click mode, the click LED indicator will be lighted up.
2. Press [PAGE] button select the click time signature page, the 3-digit-LED will display the click time signature(4-4).
3. Press [+] or [-] to adjust the value.
Range:(1/4-7/4 or 3/8 or 6/8).

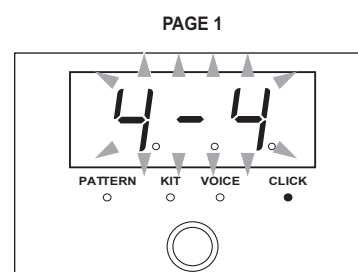

Note: The click time signature will follow the pattern, when pattern is playing, it can not be edit.

Adjust the click interval

In click mode, interval:(1/4,1/8,1/12,1/16,1/24,default 1/4).

1. Press [MODE] button to select the click mode, the click LED indicator will be lighted up.
2. Press [PAGE] button to select the click interval page, the 3-digit-LED will display the click interval(--4) .
3. Turn the DATA DIAL to adjust the value.
Range:(-4 to -24).

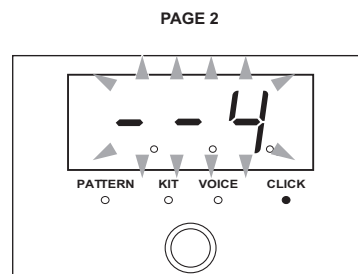

Adjust the click instrument

In click mode, instrument:(1-5,default 1).

1. Press [MODE] button to select the click mode, the click LED indicator will be lighted up.
2. Press [PAGE] button to select the click instrument page, the 3-digit-LED will display the click instrument(CL1).
3. Turn the DATA DIAL to adjust the value.
Range:(CL1 to CL5).

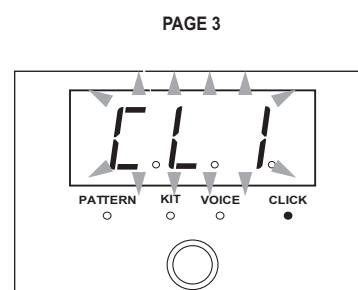

Adjust the click volume

In click mode, click volume:(0-32).

1. Press [MODE] button to select the click mode, the click LED indicator will be lighted up.
2. Press [PAGE] button to select the click volume page, the 3-digit-LED will display the click volume(L15).
3. Turn the DATA DIAL to adjust the value.
Range:(0 to 32)

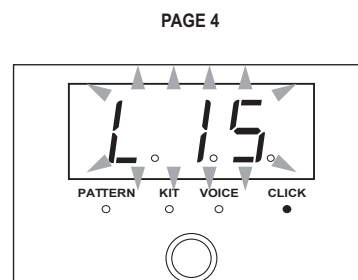

Restore the factory preset

Restoring the factory preset can be implemented by following operations:

Turn on the power with

both [MODE] and [PAGE] pressed.

This function will replace the current settings of following parameters by their default preset values:

Kit volume, voice number, voice volume and MIDI note.

Play the demo

1. Hold the [CLICK] button for 2 seconds to enter the demo and play the demo, the 3-digit-LED will display the demo "dE".
2. Press [START/STOP] button to stop the demo playing.

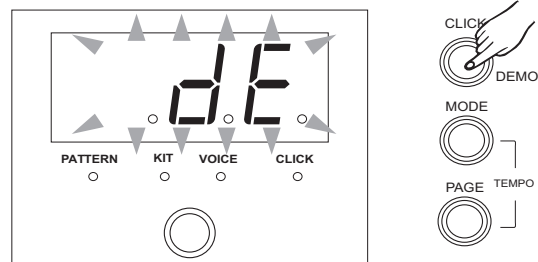

Play the pattern

1. Press [START/STOP] button play the pattern.
2. Press [START/STOP] button again to stop the pattern playing.

Play the click

1. Press the [CLICK] button to start the click, the click indicator will flash follow the beat.
2. Press the [CLICK] button again to stop the click.

Specifications

Drum Pad

4 drum pads , 3 cymbal pads ,1 hi-hat control pedal , 1 kick

Preset Drum kits

10 preset kits

Drum Instrument

108

Preset Pattern

40

Controls

MIDI OUT, POWER SWITCH, USB, PHONES, START/STOP,PATTERN, KIT, VOICE, CLICK, MODE, PAGE, DEMO, TEMPO, VOLUME, DATA DIAL

Display

LED display

Connections

PHONES
AUX IN
OUTPUT (L/MONO & R)
MIDI OUT
USB
ON/OFF

Power Supply

AC adaptor (9V ---)

Preset Drum KIT list

No.	Name
001	Acoustic
002	Standard 1
003	Rock
004	Standard 2
005	Funk
006	Jazz
007	Brush
008	Electronic
009	808
010	House

Drum Instrument List

No.	Name	No.	Name	No.	Name	No.	Name	No.	Name		
KICK											
001	Standard Kick 1	022	Acoustic Snare Rim	043	Camco Tom 4	063	Standard Crash 2	082	Bongo Low		
002	Standard Kick 2	023	Funk Band Snare	044	Camco Tom 5	064	Rock Crash	083	Mute Conga Hi-hat		
003	Room Kick	024	Funk Band Snare Rim	045	Camco Tom 6	065	Splash 1	084	Open Conga Hi-hat		
004	Rock Kick 1	025	Camco Snare	046	808 Tom 1	066	Splash 2	085	Conga Low		
005	Rock Kick 2	026	Camco Snare Rim	047	808 Tom 2	067	Brush Crash	086	Timbale High		
006	Acoustic Kick	027	Brush Snare	048	808 Tom 3	068	808 Crash	087	Timbale Low		
007	HipHop Kick	028	Brush Snare Rim	049	808 Tom 4			088	Agogo High		
008	Funk Kick	029	Electronic Snare 1	050	808 Tom 5	HI-HAT			089	Agogo Low	
009	Jazz Kick 1	030	Electronic Snare 2	051	808 Tom 6	069	Standard Hi-hat Open	090	Cabasa		
010	Jazz Kick 2	031	808 Snare	052	Electronic Tom 1	070	Jazz Hi-hat Open	091	Maracas		
011	Electronic Kick	032	House Snare 1	053	Electronic Tom 2	071	Electronic Hi-hat Open	092	Short Whistle		
012	808 Kick	033	House Snare 2	054	Electronic Tom 3	072	808 Hi-hat Open	093	Long Whistle		
013	House Kick 1			055	Electronic Tom 4	073	Standard Hi-hat Close	094	Short Guiro		
014	House Kick 2			056	Electronic Tom 5	074	Jazz Hi-hat Close	095	Long Guiro		
SNARE											
015	Classic Snare 1	TOM		057	Electronic Tom 6	075	Electronic Hi-hat Close	096	Claves		
016	Classic Snare Rim 1	034	Classic Tom 1			076	808 Hi-hat Close	097	Wood Block High		
017	Classic Snare 2	035	Classic Tom 2	RIDE						098	Wood Block Low
018	Classic Snare Rim 2	036	Classic Tom 3	058	Classic Ride	077	Standard Hi-hat Pad	099	Mute Cuica		
019	Room Snare 1	037	Classic Tom 4	059	Classic Ride Bell	078	Jazz Hi-hat Pad	100	Open Cuica		
020	Room Snare 2	038	Classic Tom 5	060	Rock Ride	079	Electronic Hi-hat Pad	101	Mute Triangle		
021	Acoustic Snare	039	Classic Tom 6	061	808 Ride	080	808 Hi-hat Pad	102	Open Triangle		
		040	Camco Tom 1	CRASH						103	Shaker
		041	Camco Tom 2	062	Standard Crash 1	PERCUSSTION				104	Jingle Bell
		042	Camco Tom 3			081	Bongo High	105	Belltrees		
								106	Castanets		
								107	Mute Surdo		
								108	Open Surdo		

Preset Pattern List

No.	Name	Tempo	Kit	No.	Name	Tempo	Kit
001	Fusion 1	103	1	021	Swing	172	6
002	Electronic & Funk	116	9	022	Latin Jazz 2	126	7
003	Modern Pop	136	1	023	Big Band 2	152	6
004	HipHop	110	9	024	3/4 Jazz	120	7
005	Latin Jazz 1	130	7	025	Jazz	150	7
006	Funk 1	120	5	026	6/8 Ballad	96	3
007	Big Band 1	170	6	027	Pop Ballad	80	3
008	Funk 2	112	1	028	Pop Bossa	120	2
009	Pop Funk 1	112	1	029	16Beat Pop	120	5
010	Fusion 2	112	1	030	Pop Shuffle	86	5
011	Funk 3	120	5	031	Samba	236	1
012	Fusion 3	108	1	032	Mambo	126	5
013	Fusion 4	116	1	033	Latin Rock	136	1
014	Pop Funk 2	106	5	034	Latin Pop	126	5
015	R&B	86	9	035	Guitar Bossa	84	5
016	Drum & Bass 1	168	9	036	Country Blues	128	3
017	Break Beat	108	5	037	Rock	100	1
018	Dance	130	9	038	Reggae	78	1
019	Drum & Bass 2	170	1	039	60's Rock	120	2
020	Latin Dance	126	5	040	Blues	96	2
				Demo Funk		100	1

GM Backing Instrument List

PIANO

- 1 Acoustic Grand Piano
- 2 Bright Acoustic Piano
- 3 Electric Grand Piano
- 4 Honky-Tonk Piano
- 5 E.Piano 1
- 6 E.Piano 2
- 7 Harpsichord
- 8 Clavi

MALLET

- 9 Celesta
- 10 Glockenspiel
- 11 Music Box
- 12 Vibraphone
- 13 Marimba
- 14 Xylophone
- 15 Tubular Bells
- 16 Dulcimer

ORGAN

- 17 Drawbar Organ
- 18 Percussive Organ
- 19 Rock Organ
- 20 Church Organ
- 21 Reed Organ
- 22 Accordion
- 23 Harmonica
- 24 Tango Accordion

GUITAR

- 25 Nylon Guitar
- 26 Steel Guitar
- 27 Jazz Guitar
- 28 Clean Guitar
- 29 Muted Guitar
- 30 Overdriven Guitar
- 31 Distortion Guitar
- 32 Guitar Harmonics

BASS

- 33 Acoustic Bass
- 34 Finger Bass
- 35 Pick Bass
- 36 Fretless Bass
- 37 Slap Bass 1
- 38 Slap Bass 2
- 39 Synth Bass 1
- 40 Synth Bass 2

STRINGS

- 41 Violin
- 42 Viola
- 43 Cello
- 44 Contrabass
- 45 Tremolo Strings
- 46 Pizzicato Strings
- 47 Orchestral Harp
- 48 Timpani

STRINGS ENSEMBLE

- 49 Strings Ensemble 1
- 50 Strings Ensemble 2
- 51 Synth Strings 1
- 52 Synth Strings 2
- 53 Choir Aahs
- 54 Voice Oohs
- 55 Synth Voice
- 56 Orchestra Hit

BRASS

- 57 Trumpet
- 58 Trombone
- 59 Tuba
- 60 Muted Trumpet
- 61 French Horn
- 62 Brass Section
- 63 Synth Brass 1
- 64 Synth Brass 2

REED

- 65 Soprano Sax
- 66 Alto Sax
- 67 Tenor Sax
- 68 Baritone Sax
- 69 Oboe
- 70 English Horn
- 71 Bassoon
- 72 Clarinet

PIPE

- 73 Piccolo
- 74 Flute
- 75 Recorder
- 76 Pan Flute
- 77 Blown Bottle
- 78 Shakuhachi
- 79 Whistle
- 80 Ocarina

LEAD

- 81 Lead1 (square)
- 82 Lead2 (sawtooth)
- 83 Lead3 (calliope)
- 84 Lead4 (chiff)
- 85 Lead5 (charang)
- 86 Lead6 (voice)
- 87 Lead7 (fifths)
- 88 Lead8 (bass & Lead)

PAD

- 89 Pad1 (newage)
- 90 Pad2 (warm)
- 91 Pad3 (Polysynth)
- 92 Pad4 (choir)
- 93 Pad5 (bowed)
- 94 Pad6 (metallic)
- 95 Pad7 (halo)
- 96 Pad8 (sweep)

EFFECTS

- 97 FX1 (rain)
- 98 FX2 (soundtrack)
- 99 FX3 (crystal)
- 100 FX4 (atmosphere)
- 101 FX5 (brightness)
- 102 FX6 (goblins)
- 103 FX7 (echoes)
- 104 FX8 (sci-fi)

ETHNIC

- 105 Sitar
- 106 Banjo
- 107 Shamisen
- 108 Koto
- 109 Kalimba
- 110 Bagpipe
- 111 Fiddle
- 112 Shanai

PERCUSSIVE

- 113 Tinkle Bell
- 114 Agogo
- 115 Steel Drums
- 116 Wood Block
- 117 Taiko Drum
- 118 Melodic Tom
- 119 Synth Drum
- 120 Reverse Cymbal

SOUND EFFECTS

- 121 Guitar Fret Noise
- 122 Breath Noise
- 123 Seashore
- 124 Bird Tweet
- 125 Telephone Ring
- 126 Helicopter
- 127 Applause
- 128 Gunshot

GM Drum Kit List

NET NO.	Standard 1 (bank 0)	Standard 2 (bank 4)	Room (bank 8)	Rock (bank 16)	Funk (bank 17)
27-D#1	High Q	<-	<-	<-	<-
28-E1	Slap	<-	<-	<-	<-
29-F1	Scratch Push	<-	<-	<-	<-
30-F#1	Scratch Pull	<-	<-	<-	<-
31-G1	Sticks	<-	<-	<-	<-
32-G#1	Square Click	<-	<-	<-	<-
33-A1	Metronome Click	<-	<-	<-	<-
34-A#1	Metronome Bell	<-	<-	<-	<-
35-B1	Acoustic Bass Drum	<-	Room Bass Drum 1	Rock Bass Drum 1	Funk Bass Drum 1
36-C2	Standard 1 Bass Drum	Standard 2 Bass Drum	Room Bass Drum 2	Rock Bass Drum 2	Funk Bass Drum 2
37-C#2	Side Stick	<-	<-	<-	<-
38-D2	Standard 1 Snare	Standard 2 Snare	Room Snare	Rock Snare	Funk Snare
39-D#2	Hand Clap	<-	<-	<-	<-
40-E2	Standard 1 Snare Rim	Standard 2 Snare Rim	Room Snare Rim	Rock Snare Rim	Funk Snare Rim
41-F2	Standard 1 Tom 6	Standard 2 Tom 6	Room Tom 6	Rock Tom 6	Funk Tom 6
42-F#2	Standard 1 Hi-hat Close	Standard 2 Hi-hat Close	Room Hi-hat Close	Rock Hi-hat Close	Funk Hi-hat Close
43-G2	Standard 1 Tom 5	Standard 2 Tom 5	Room Tom 5	Rock Tom 5	Funk Tom 5
44-G#2	Standard 1 Hi-hat Pedal	Standard 2 Hi-hat Pedal	Room Hi-hat Pedal	Rock Hi-hat Pedal	Funk Hi-hat Pedal
45-A2	Standard 1 Tom 4	Standard 2 Tom 4	Room Tom 4	Rock Tom 4	Funk Tom 4
46-A#2	Standard 1 Hi-hat Open	Standard 2 Hi-hat Open	Room Hi-hat Open	Rock Hi-hat Open	Funk Hi-hat Open
47-B2	Standard 1 Tom 3	Standard 2 Tom 3	Room Tom 3	Rock Tom 3	Funk Tom 3
48-C3	Standard 1 Tom 2	Standard 2 Tom 2	Room Tom 2	Rock Tom 2	Funk Tom 2
49-C#3	Standard 1 Crash 1	Standard 2 Crash 1	Room Crash 1	Rock Crash 1	Funk Crash 1
50-D3	Standard 1 Tom 1	Standard 2 Tom 1	Room Tom 1	Rock Tom 1	Funk Tom 1
51-D#3	Standard 1 Ride	Standard 2 Ride	Room Ride	Rock Ride	Funk Ride
52-E3	Chinese Cymbal 1	<-	<-	<-	<-
53-F3	Ride Bell	<-	Room Ride Bell	Rock Ride Bell	<-
54-F#3	Tambourine	<-	<-	<-	<-
55-G3	Splash Cymbal	<-	Room Splash Cymbal	Rock Splash Cymbal	<-
56-G#3	Standard 1 Cowbell	Standard 2 Cowbell	Room Cowbell	Rock Cowbell	<-
57-A3	Standard 1 Crash 2	Standard 2 Crash 2	Room Crash 2	Rock Crash 2	Funk Crash 2
58-A#3	Vibra-slap	<-	<-	<-	<-
59-B3	Ride Cymbal	<-	<-	<-	<-
60-C4	Hi Bongo	<-	<-	<-	<-
61-C#4	Low Bongo	<-	<-	<-	<-
62-D4	Mute Hi Conga	<-	<-	<-	<-
63-D#4	Open Hi Conga	<-	<-	<-	<-
64-E4	Low Conga	<-	<-	<-	<-
65-F4	High Timbale	<-	<-	<-	<-
66-F#4	Low Timbale	<-	<-	<-	<-
67-G4	High Agogo	<-	<-	<-	<-
68-G#4	Low Agogo	<-	<-	<-	<-
69-A4	Cabasa	<-	<-	<-	<-
70-A#4	Maracas	<-	<-	<-	<-
71-B4	Short Whistle	<-	<-	<-	<-
72-C5	Long Whistle	<-	<-	<-	<-
73-C#5	Short Guiro	<-	<-	<-	<-
74-D5	Long Guiro	<-	<-	<-	<-
75-D#5	Claves	<-	<-	<-	<-
76-E5	Hi Wood Block	<-	<-	<-	<-
77-F5	Low Wood Block	<-	<-	<-	<-
78-F#5	Mute Cuica	<-	<-	<-	<-
79-G5	Open Cuica	<-	<-	<-	<-
80-G#5	Mute Triangle	<-	<-	<-	<-
81-A5	Open Triangle	<-	<-	<-	<-
82-A#5	Shaker	<-	<-	<-	<-
83-B5	Jingle Bell	<-	<-	<-	<-
84-C6	Bell Tree	<-	<-	<-	<-
85-C#6	Castanets	<-	<-	<-	<-
86-D6	Mute Surdo	<-	<-	<-	<-
87-D#6	Open Surdo	<-	<-	<-	<-

GM Drum Kit List

NET NO.	Electronic (bank 24)	808 (bank 25)	House (bank 28)	Jazz (bank 32)	Brush (bank 40)
27-D#1	<-	<-	<-	<-	<-
28-E1	<-	<-	<-	<-	<-
29-F1	<-	<-	<-	<-	<-
30-F#1	<-	<-	<-	<-	<-
31-G1	<-	<-	<-	<-	<-
32-G#1	<-	<-	<-	<-	<-
33-A1	<-	<-	<-	<-	<-
34-A#1	<-	<-	<-	<-	<-
35-B1	Electronic Bass Drum 1	808 Bass Drum 1	House Bass Drum 1	Jazz Bass Drum 1	Brush Bass Drum 1
36-C2	Electronic Bass Drum 2	808 Bass Drum 2	House Bass Drum 2	Jazz Bass Drum 2	Brush Bass Drum 2
37-C#2	<-	<-	<-	<-	<-
38-D2	Electronic Snare	808 Snare	House Snare	Jazz Snare	Brush Snare
39-D#2	<-	<-	House Hand Clap	<-	<-
40-E2	Electronic Snare Rim	808 Snare Rim	House Snare Rim	Jazz Snare Rim	Brush Snare Rim
41-F2	Electronic Tom 6	808 Tom 6	House Tom 6	Jazz Tom 6	Brush Tom 6
42-F#2	Electronic Hi-hat Close	808 Hi-hat Close	House Hi-hat Close	Jazz Hi-hat Close	<-
43-G2	Electronic Tom 5	808 Tom 5	House Tom 5	Jazz Tom 5	Brush Tom 5
44-G#2	Electronic Hi-hat Pedal	808 Hi-hat Pedal	House Hi-hat Pedal	Jazz Hi-hat Pedal	<-
45-A2	Electronic Tom 4	808 Tom 4	House Tom 4	Jazz Tom 4	Brush Tom 4
46-A#2	Electronic Hi-hat Open	808 Hi-hat Open	House Hi-hat Open	Jazz Hi-hat Open	<-
47-B2	Electronic Tom 3	808 Tom 3	House Tom 3	Jazz Tom 3	Brush Tom 3
48-C3	Electronic Tom 2	808 Tom 2	House Tom 2	Jazz Tom 2	Brush Tom 2
49-C#3	<-	808 Crash 1	<-	<-	Brush Crash 1
50-D3	Electronic Tom 1	808 Tom 1	House Tom 1	Jazz Tom 1	Brush Tom 1
51-D#3	<-	<-	<-	Jazz Ride	Brush Ride
52-E3	<-	<-	<-	<-	<-
53-F3	<-	<-	<-	<-	<-
54-F#3	<-	<-	<-	<-	<-
55-G3	<-	<-	<-	<-	<-
56-G#3	<-	<-	<-	<-	<-
57-A3	<-	808 Crash 2	<-	ChineseCymbal 2	Brush Crash 2
58-A#3	<-	<-	<-	<-	<-
59-B3	<-	<-	<-	<-	<-
60-C4	<-	<-	<-	<-	<-
61-C#4	<-	<-	<-	<-	<-
62-D4	<-	808 Mute Hi Conga	<-	<-	<-
63-D#4	<-	808 Open Hi Conga	<-	<-	<-
64-E4	<-	808 Low Conga	<-	<-	<-
65-F4	<-	<-	<-	<-	<-
66-F#4	<-	<-	<-	<-	<-
67-G4	<-	<-	<-	<-	<-
68-G#4	<-	<-	<-	<-	<-
69-A4	<-	<-	<-	<-	<-
70-A#4	<-	808 Maracas	<-	<-	<-
71-B4	<-	<-	<-	<-	<-
72-C5	<-	<-	<-	<-	<-
73-C#5	<-	<-	<-	<-	<-
74-D5	<-	<-	<-	<-	<-
75-D#5	<-	808 Claves	<-	<-	<-
76-E5	<-	<-	<-	<-	<-
77-F5	<-	<-	<-	<-	<-
78-F#5	<-	<-	<-	<-	<-
79-G5	<-	<-	<-	<-	<-
80-G#5	<-	<-	<-	<-	<-
81-A5	<-	<-	<-	<-	<-
82-A#5	<-	<-	<-	<-	<-
83-B5	<-	<-	<-	<-	<-
84-C6	<-	<-	<-	<-	<-
85-C#6	<-	<-	<-	<-	<-
86-D6	<-	<-	<-	<-	<-
87-D#6	<-	<-	<-	<-	<-

MIDI Implementation Chart

	Function...	Transmitted	Recognized	Remarks
Basic Channel	Default	10 ch	1-16	
	Changed	X	X	
Mode	Default	X	X	
	Messages Altered	X *****	X *****	
Note Number:	True voice	0-127 *****	0-127 0-127	
Velocity	Note on	○ 99H, V=1-127	0-127	
	Note off	○ (9 9H. V=0)	0-127	
After Touch	Key's	X	X	
	Channel's	X	X	
Pitch Bend		X	○	
Control Change	0	X	○	Bank Select
	1	X	○	Modulation
	5	X	○	Portamento Time
	6	X	○	Data Entry
	7	X	○	Volume
	10	X	○	Pan
	11	X	○	Expression
	64	X	○	Sustain Pedal
	65	X	○	Portamento ON/OFF
	66	X	○	Sostenuto Pedal
	67	X	○	Soft Pedal
	80	X	○	Reverb Program
	81	X	○	Chorus Program
	91	X	○	Reverb Level
	93	X	○	Chorus Level
	120	X	○	All Sound OFF
121	X	○	Reset All Controller	
123	X	○	All Notes OFF	
Program Change		X	○	
System Exclusive		X	○	
System Common	: Song Position	X	X	
	: Song Select	X	X	
	: Tune	X	X	
System Real Time	: Clock	○	X	START \ STOP
	: Commands	○	X	
Aux Messages	: Local ON/OFF	X	X	
	: All Notes OFF	X	X	
	: Active Sense	○	X	
	: Reset	X	X	

○ : YES
X : NO

